

CROSSROADS TECHNICAL INSTRUMENTATION REPORT

746 Timing Signals (IV-12)

~~UNCLASSIFIED~~

-- H. G. Weiss..

DO NOT CIRCULATE

SCANNED NOV 13 1996

PERMANENT RETENTION

REQUIRED BY CONTRACT





UNCLASSIFIED

LANS - 430

This is copy 10 of 10 copies

September 1, 1944

This document contains 53 p.
27 p. fl.

CROSSROADS TECHNICAL INSTRUMENTATION REPORT:

TRIGGER SIGNALS (TRUST A AND B)

(u) PL
6.27.83

By

H. G. Weiss

UNCLASSIFIED



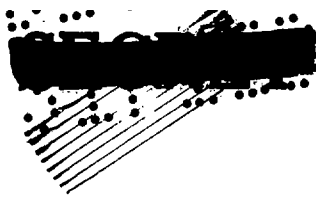

UNCLASSIFIED

UNCLASSIFIED

This Document Contains 53
No. of Pages. Copy 10 of 10
Copies. *32 Figures*

~~This document contains information regarding the name of the person who furnished the information to the person to whom it is being furnished. The name of the person to whom it is being furnished is [redacted].~~

UNCLASSIFIED



UNCLASSIFIED

UNCLASSIFIED

Crossroads Technical Instrumentation ReportTests A and B

1 September 1946

From: Los Alamos Field Group 013H
To: Technical Director, JTF-1
Project No.: IV - 12
Subject: Timing Signals

Prepared by: H.G. Weiss
Approved: M.G. Holloway

M G Holloway

Abstract

Described in this report are the radio-links used in Tests Able and Baker for the remote operation of the various instrumentation. Discussed are the timing control laboratory and the portable timing units, their design, construction, and maintenance. Also included is a critique of the equipment on the basis of the experience gained in the two tests.

UNCLASSIFIED



TABLE OF CONTENTS

I GENERAL - - - - - 4

- 1.1. Historical Background
- 1.2. Design Philosophy

UNCLASSIFIED

II THE TIMING CONTROL LABORATORY - - - - - 8

- 2.1) Background
- 2.2) Construction
- 2.3) Description of Equipment
 - 2.3.1) Transmitters
 - 2.3.1) Monitors
 - 2.3.3) Modulation Equipment
 - 2.3.4) Keying System
 - 2.3.5) Timing Clocks
 - 2.3.6) Automatic Starting Device
 - 2.3.7) Control Console

III THE TIMING UNITS - - - - - -22

- 3.1) Function
- 3.2) General Description
- 3.3) Timing Unit Components
 - 3.3.1) Receiver
 - 3.3.2) Filter-Relay Unit
 - 3.3.3) Battery Supply
 - 3.3.4) Clock
 - 3.3.5) Antenna
 - 3.3.6) Waterproof Box
- 3.4) Timing Unit Test Box
- 3.5) Production Scheduling and Facilities
- 3.6) Test Procedure on the USS CUMBERLAND SOUND

UNCLASSIFIED

IV FIELD ACTIVITIES - - - - - -31

- 4.1) General
- 4.2) Installations
- 4.3) Field Maintenance
- 4.4) The Final Operations
- 4.5) Interference
- 4.6) List of Test Able Installations
- 4.7) List of Test Baker Installations

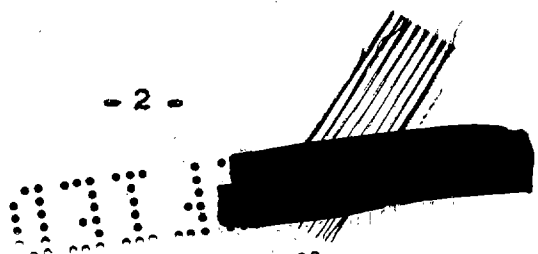

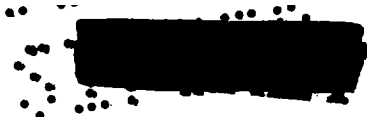

V SUMMARY OF RESULTS - - - - - 46

5.1) Test Able

5.2) Test Baker

VI RECOMMENDATIONS FOR IMPROVEMENTS - - - - - 48

6.1) General

6.2) Timing Control Laboratory

6.3) The Timing Units

VII ACKNOWLEDGMENTS - - - - - 52

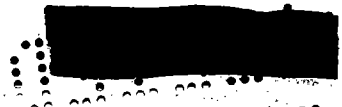

REPORT ON THE CROSSROADS INSTRUMENTATION TIMING PROGRAMI. General1-1 Historical Background

The need for a coordinated timing system for all the activities participating in the Crossroads operation became evident soon after detailed planning for the operation was initiated; and a group of meetings were held in Washington in mid-January 1946 to study the timing requirements. The principle demand for accurate timing information arose from the instrumentation groups who desired to activate equipment at specific time intervals prior to the bomb detonation. Practically all of these instruments were unmanned; and were to be located on target vessels, on islands in Bikini Atoll, and in aircraft. It became evident that a central control station capable of transmitting radio signals to all the remote installations and suitable receiving equipment capable of responding to the transmitted signals would be required. The various instruments required starting signals at the following time intervals: -30 min., -2 min., -20 sec, -5 sec, and -2sec. measured with respect to the instant of explosion. At the time this program was under discussion Able Day and had been scheduled for May 15th and installation of equipment was required at Bikini by May 1st. To meet this schedule, production would have to be completed and equipment made available for shipment before April 15th. It soon became painfully obvious that the most formidable task in the timing program would be the design, procurement, and manufacture of several hundred special radio receiving units in the short period of 10 weeks.

The discussions in Washington indicated the advisability of placing the responsibility for the complete timing program with a single agency. There was no one Navy agency prepared to undertake



[REDACTED]

this large scale "crash" program alone and deliver completed units in the desired time. Since close liaison between the bomb detonation process and the timing organization was required, and since the responsibility for firing the Baker Bomb rested with Los Alamos, and a system of radio links and time clocks was already under consideration for that program, it appeared that Los Alamos was the organization participating in the Crossroads tests best prepared to undertake the timing program. However, the only hope of meeting the required time schedule rested in the use of equipment already available in Army or Navy supply depots. In addition a staff of approximately twenty people, not available at Los Alamos, would have to be rapidly recruited to carry out the work. After considerable discussion the following arrangement was finally agreed upon:

1) The overall administrative and technical responsibility for the timing program would be assigned to Los Alamos.

2) Approximately ten Navy enlisted radio technicians and suitable production facilities would be made available at a West Coast Navy yard to assist in the construction of the timing boxes. These technicians would be available to aid in the field maintenance of the equipment at Bikini.

3) Manhattan District procurement facilities would be employed to obtain necessary electronic equipment not readily available from Navy stocks.

4) A suitable transmitter and timing control installation would be made on the Los Alamos Laboratory ship, the USS Cumberland Sound, AV-17.

5) Field installation and servicing of timing units would be undertaken by Los Alamos with the aid of Navy enlisted personnel.

It was realized from the outset that the amount of work to be accomplished was very great considering the time available, and a work schedule was laid down calling for a major "crash" procurement and production program. Very heavy and frequently unreasonable requirements were made upon the Manhattan District procurement facilities, the Terminal Island Navy Drydocks, and the Navy's Crossroads Electronics Officer. The fact that the work was completed ahead of schedule testifies to the success with which each agency carried out its part of the program.

1.2. Design Philosophy

Because of the very limited time available for the design and production of equipment, the timing system would have to be as simple as possible and make maximum use of standard readily available components. It was recognized that a system using several frequencies or special coding would provide added security and reliability but it was felt that a single receiver and simple filter system could be made to provide satisfactory performance, and that, this form of system would have to be used to meet the required time schedule. Due to the large number of receiving locations and conditions, some at sea level and over thirty miles away, and the desirability of using an elementary antenna system which would be least affected by signals reflected from nearby objects, it appeared desirable to use a relatively low radio frequency. On the other hand, the use of a high radio frequency would increase the efficiency of a physically short antenna. The availability of SCR 694 receivers, which were suitable for this application because of performance, size, and battery requirements, necessitated the choice of an operating frequency in the range from 3.5 to 6.0 megacycles per second. The use of a standard radio receiver also necessitated employing modulation frequencies within its audio response band, that is, within 300 to 2000 cycles per second. Thus it can be seen that most of the basic system

specifications were determined by the necessity of working with available standard equipment only.

In order to obtain maximum reliability and freedom from interference it was felt imperative to make use of the highest-powered standard shipboard transmitter that was consistent with availability and space requirements. To further aid in suppressing interference it was decided to keep the transmitter carrier on the air whenever the timing receivers were energized and to make use of high modulation percentages.

Since a survey indicated that the instrumentation equipment could be activated by switch closings at just one or two time intervals and because of the short production time that was available it was decided to limit the total number of channels in any one box to three. In order to cope with a possible delay of the test after the 90 minute or 2 minute signals had been transmitted it appeared desirable to incorporate a recycle channel in the unit which could open any relays previously closed. It did not appear practical to install mechanical locking circuits on the relays without delay and a great increase in the size of the box and although the relays chosen were to be capable of withstanding accelerations of the order of 20 G's they were not guaranteed to remain closed during the blast.

Because of the high humidity and frequent rain encountered in the tropics it was decided to place the complete timing unit in a waterproof box and to employ a generous quantity of silica gel to aid in keeping the equipment dry. In actual operation it would be necessary to abandon the timing units a day prior to the actual explosion. Therefore, it was considered advisable to incorporate a spring-

[REDACTED]

wound clock in each box which would energize the unit shortly before the explosion time, thereby reducing the probability of prefiring on random interference and at the same time conserving battery power. To simplify field servicing it was decided to employ dry batteries and to provide sufficient capacity to operate the unit for a period greater than thirty hours. The range of signal intensities available made it possible to employ a short antenna, and for convenience, provision was made to install a whip antenna of adjustable length directly on the waterproof box that would contain the timing unit.

II. The Timing Laboratories Installed on the AV-17

2.1 Background

In test Able, the sole function of the timing control laboratories aboard the AV-17 was to transmit a series of tone signals at suitable intervals before the explosion of the bomb. The expected time of bomb release, was to be transmitted to the AV-17 by radio in the form of a break of a 1 kc tone modulation. Since the time of fall (of the order of 1 minute) before explosion was accurately known, the time of the explosion could be predicted and the tone signals sent out accordingly. To reduce the human error, the 1 kc tone break was used to start automatically a motor-driven interval marker which automatically keyed out the last three tones: -20 seconds, -5 seconds, and -2 seconds. In addition to this automatic "clock", there was required a transmitter (Navy type TBM; 400 watts output), audio oscillators, a means of recording the times at which the tones were broadcast and suitable equipment for communicating with the bombing plane and with CJTF-1.

For Test Baker, there was added the function of detonating the bomb by a radio link originating aboard the AV-17. The synchron-

[REDACTED]

izing problem no longer existed, since timing and firing signals were sent out simultaneously by the action of a single key for each time. In addition, a "repeat-back" link was required, which informed the ship that the various firing steps aboard the bomb-carrying barge had been successfully completed. A "gamma timing" link was also required, to measure the time interval between the closing of the final detonator switch and the start of the nuclear reaction, as evidenced by the appearance of gamma-rays at a chamber a few feet from the center of the bomb.

The basic plans for the above equipment were laid down at the start of the program. It was decided to use a triple radio link for the firing process, so arranged that no one link would suffice, but that any one link could fail without impairing the firing. Thus, five transmitters were required: one for timing, three for firing, and a spare.

2.2. Construction

Construction of the laboratories and installations of the transmitters was done by the Navy at the U.S. Naval Drydock Station at Terminal Island, Long Beach, Calif. Two laboratories were built on the Signal Bridge of the AV-17. The starboard laboratory, some 40' x 14', contained the transmitters, as well as three Navy type RBB receivers to monitor the firing transmitters, an RBC to monitor the timing transmitter, and a spare RBC. The port laboratory (Fig. 2) was for the timing and firing control equipment. Interconnections between the two laboratories and benches were provided by the Navy at Terminal Island, but the control equipment was built and installed by the Los Alamos Field Group.

Work on the Control equipment was started at Los Alamos during February, and several of the relay racks were completed there, but the bulk of the work was done aboard the ship during the period from March 15,

[REDACTED]

STBD SIGNAL BRIDGE TIMING CONTROL
TRANSMITTER ROOM
14' X 40'

STBD

FWD

AFT

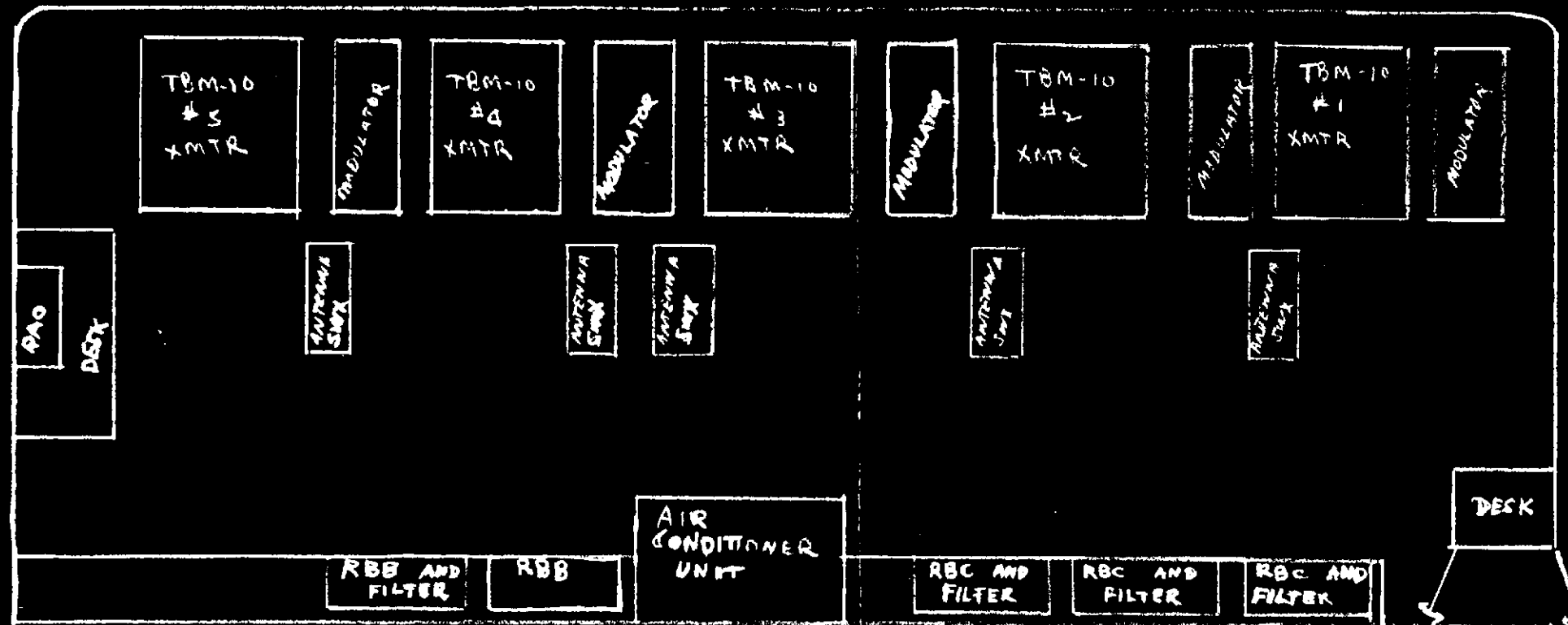

INBOARD

Figure 1. Transmitter Room layout

| | | | | | | | | | |
|---------------------------|-----------|---------------------|----------|------|----------------------|------------------|---------------------------|-------------------------|-----|
| | | APPROVED FOR CONST. | | | NEXT ASSEM. | FINAL ASSEM. | DASH NO. OR STD. PART NO. | ASSEM. NO. | SHT |
| | | CHIEF ENG. | | | NO. REQ'D PER ASSEM. | | | NEXT ASSEMBLY | |
| | | PROJ. ENG. | | | | | | | |
| | | CHECKED | | | | | | | |
| | | DRAWN | | | | | | | |
| GROUP REPR. | GROUP NO. | LAYOUT OR SKETCH | | | | | | | |
| | | FINISHES | INITIALS | DATE | REV. LET. | CHANGED ITEM WAS | | DATE | BY |
| (A) | | GROUND | | | | MODEL OR TITLE | SCALE | | |
| (B) | | SMOOTH MACHINE | | | | | DRAWING NO. | | |
| (C) | | ROUGH MACHINE | | | | | JOB NO. | SHEET SIZE NO. B | |
| TOLERANCE EXCEPT AS NOTED | | SUPERSEDES | | | | | | | |
| FRACTIONAL | ±1/64 | SUPERSEDED BY | | | | | | | |
| ANGLES | ±1/2° | | | | | | | | |
| SHEET METAL | ±1/32 | | | | | | | | |
| DECIMALS | NOTED | | | | | | | TOTAL | |

FWD

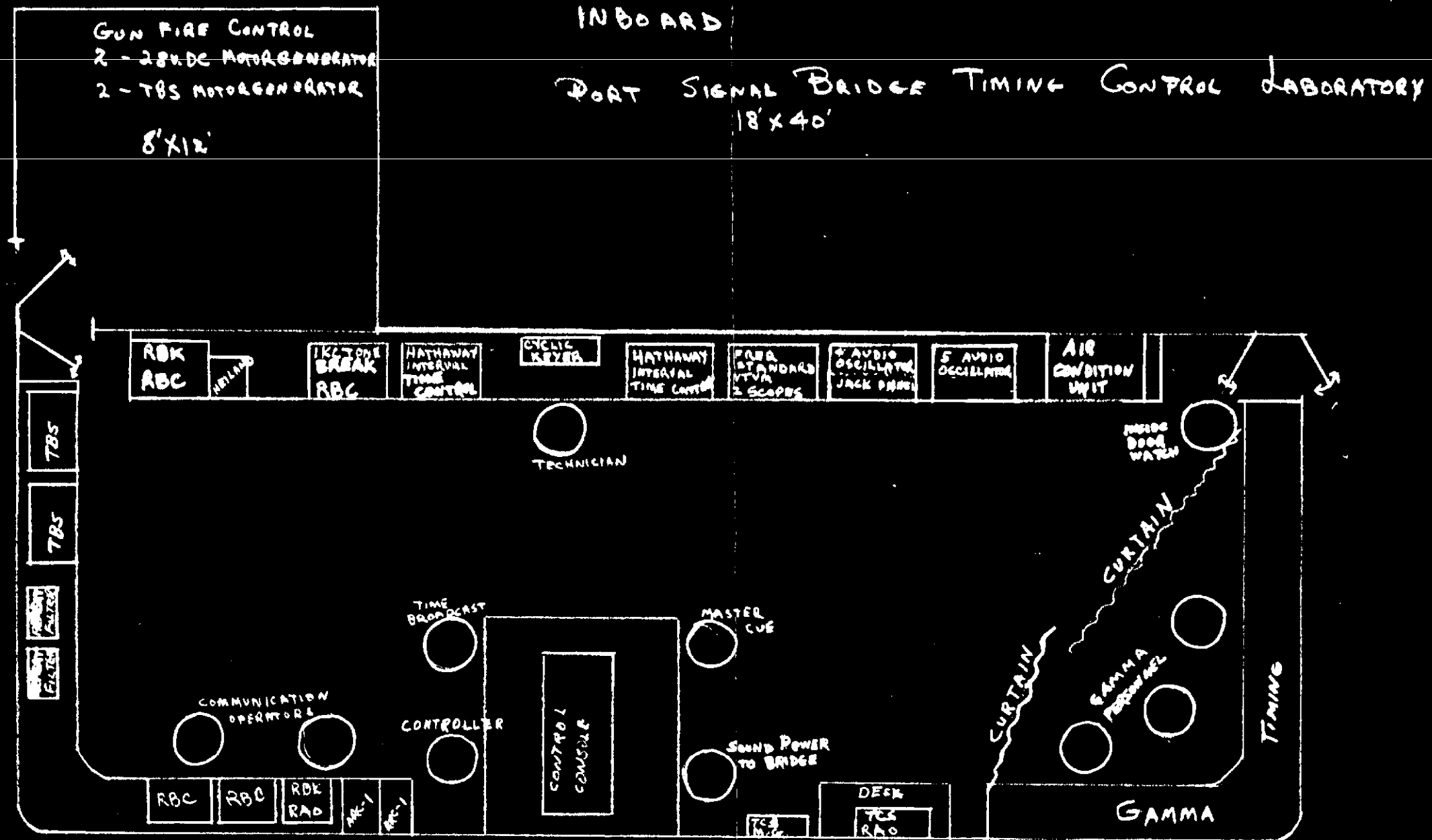

AFT

PORT

Figure 2. Timing Control Laboratory Layout

| | | | | | | | | | |
|-------------|-----------|---------------------------|---------------|----------|----------------------|--------------|---------------------------|------------------|-------|
| | | APPROVED FOR CONST. | | | NEXT ASSEM. | FINAL ASSEM. | DASH NO. OR STD. PART NO. | ASSEM. NO. | SMT |
| | | CHIEF ENG. | | | NO. REQ'D PER ASSEM. | | | NEXT ASSEMBLY | |
| | | PROJ. ENG. | | | | | | | |
| | | CHECKED | | | | | | | |
| | | DRAWN | | | | | | | |
| GROUP REPR. | GROUP NO. | LAYOUT OR SKETCH | | | | | | | |
| | | FINISHES | | INITIALS | DATE | REV. LET. | CHANGED ITEM WAS | DATE | BY |
| | | GROUND | | | | | MODEL OR TITLE | SCALE | |
| | | SMOOTH MACHINE | CALC. WT. | | | | DRAWING NO. | SHEET SIZE NO. B | |
| | | ROUGH MACHINE | ACT. WT. | | | | | JOB NO. | TOTAL |
| | | TOLERANCE EXCEPT AS NOTED | SUPERSEDES | | | | | | |
| | | FRACTIONAL ±1/64 | SUPERSEDED BY | | | | | | |
| | | ANGLES ±1/2° | | | | | | | |
| | | SHEET METAL ±1/32 | | | | | | | |
| | | DECIMALS NOTED | | | | | | | |

until the test itself. The automatic timing clocks were designed and built by the Hathaway Instrument Co. of Denver, Colo., to specifications provided by Los Alamos. Two complete units were delivered aboard the AV-17 early in April.

When the 6 weeks' delay was ordered by President Truman, it was decided to build a Master control console at which all the monitor and repeat-back pilot lights would be centralized and from which the tones could be keyed-out and the automatic timing clocks operated. The console cabinet was designed and built during April, at Terminal Island, but the detailed circuitry, the actual installation of parts, and the wiring were done enroute to Bikini.

2.3. Description of the Equipment

2.3.1. Transmitters

The time-tested, heavy duty TBM transmitters proved to be excellent in every respect. After some difficulties of false channel operation of timing boxes from harmonics (e.g. a timing channel with a 1620 cycle filter operating when the transmitter was modulated with an 850 cycle tone), an oscilloscope was installed to monitor the R-F envelope from the transmitter. The trouble was quickly traced to the improper procedure of trying to get low power by using "Step 2" of the "Tune-up" switch. It was found that the transmitters gave excellent wave-shapes even at 100% modulation when correctly operated.

One small modification to the transmitters was made. Referring to Page B-64 of the TBM Preliminary Instruction Manual (Dwg. #N-7300550), pairs of lines were run from tie points 33 and 34 of the modulators to the patch panel in the timing control room, where

[REDACTED]

switches were provided to short circuit each pair. It will be seen that these closures cause the keying relays to operate, putting the carriers on the air by remote control. To control modulation, tie points 17 and 18 in the modulator were used. These were connected to contacts on the keying relay, and were short-circuited whenever the carrier is on. The grounded lead on switch S-405D was removed, a line run from point 18 to this switch contact, and another from point 17 to ground. Thus, when the keying relay opened, the cathode of the modulator amplifier was disconnected from ground, and the amplifier became dead. This was done to avoid high voltages at the final modulator amplifier plate that exist when the amplifier is excited in the absence of carrier. Remote control of modulation, with carrier on, was provided by SPDT switches at the patch panel which could switch the signal input line from the modulator over to a fixed 600 ohm load. The signal source hence looked into 600 ohms irrespective of whether modulation was on or off. The transmitter final amplifier was operated at 2250 volts and 200 ma. Standard heavy-duty Navy vertical whips, 38 feet high, were used for antennas.

2.3.2. Monitors.

Each transmitter was provided with a monitor consisting of a receiver tuned to the carrier frequency, whose audio output was applied to a multi-channel filter unit. Figure 3 is the circuit diagram of a typical channel. When the transmitter is modulated at the filter frequency, the audio output signal from the receiver will pass through the filter and be amplified by the triode V-1a. The output of this amplifier is applied to the cathode of the diode-connected triode, V-1b, causing it to develop a positive voltage. The relay-tube, V-2, is normally biased far beyond the cut-off point by a 45-volt battery, but when the voltage from the rectifier is applied to its grid, it conducts, and the plate-current, passing through the relay windings causes it to operate. One set of relay contacts, K-1b holds the relay closed after the

transmitter modulation is removed; the other set, K-1b, lights a pilot-lamp on the filter-unit chassis and a second lamp on the control console. This gives the console operator direct evidence that a signal has gone out on the air.

2.3.3. Modulation Equipment.

Most of the modulation control equipment was mounted in six relay racks mounted on benches against the inboard wall of the timing control laboratory, as shown in Fig. 4. Figure 5 shows the general nature of the interconnections among these racks and from the racks to the transmitter room and to the master control console. Figure 6 is a functional block diagram of these interconnections.

Seven audio frequencies from 300 to 2270 cps were used to modulate the transmitters. Their functions are tabulated below:

| <u>Frequency</u> | <u>Timing Function</u> | <u>Firing Function</u> |
|------------------|------------------------|------------------------|
| 1150 | -30 minutes | - - - - - |
| 610 | -2 minutes | Charge |
| 300 | -20 seconds | - - - - - |
| 850 | -5 seconds | Arm |
| 420 | -2 seconds | - - - - - |
| 1620 | - - - - - | Fire |
| 2270 | Recycle | Disarm |

Relays racks 1 and 2 contain the seven regular oscillators and two spare oscillators as well as a panel of "substitution jacks", so arranged that a spare could be substituted for any one of the regular oscillators merely by inserting a plug in the appropriate jack.

From the substitution panel seven leads and a common ground carried the audio voltages to a voltmeter and adjustment panel in Rack 3. Here they were applied to potentiometers; one in the case of tones used for timing only, and two in parallel in the case of tones used for both timing and firing. An 11-position selector switch connected any

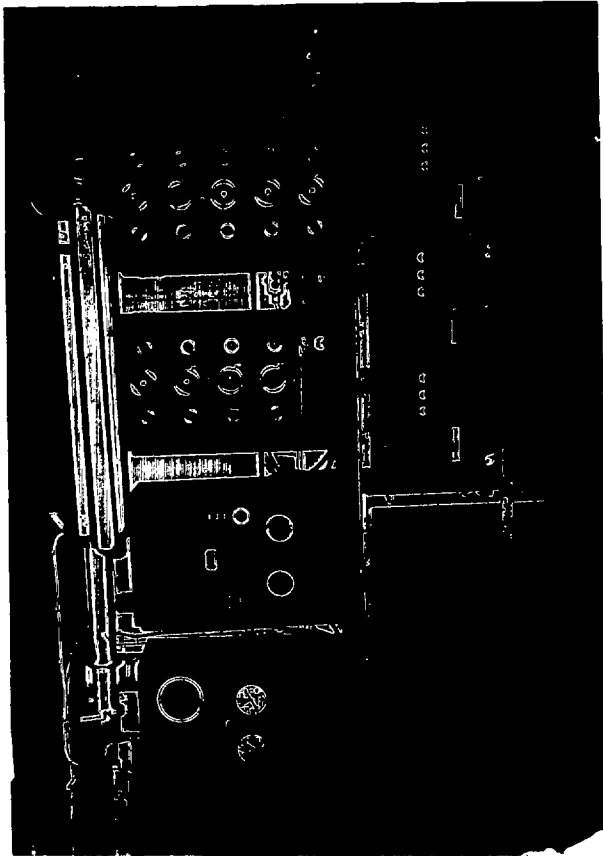

Rack 1

1. -5 sec. (850 cps)
2. -20 sec. (300 cps)
3. -2 min. (610 cps)
4. -30 min. (1150 cps)
5. Recycle (1620 cps)

Rack 2

1. "Fire" (2270 cps)
2. -2 sec. (420 cps)
3. Spare
4. Spare
5. Substitution, Panel

Rack 3

1. 100-1000 cycle Freq. Standard
2. VTVM & Audio Voltage Controls
3. Left: TBM Monitor Oscilloscope
Right: Audio Voltage Monitor

Rack 4
Clock B

1. Left: Cam-setting Dial
Right: Record Chart
2. Left: Precision Clock
Right: "Seconds-to-go" Clock
3. Tone Keys & Pilot Lights

Top: Connection Box; Modulation
Master Gain Controls
Middle: Modulation Patch Panel

Bottom: Cyclic Keyer

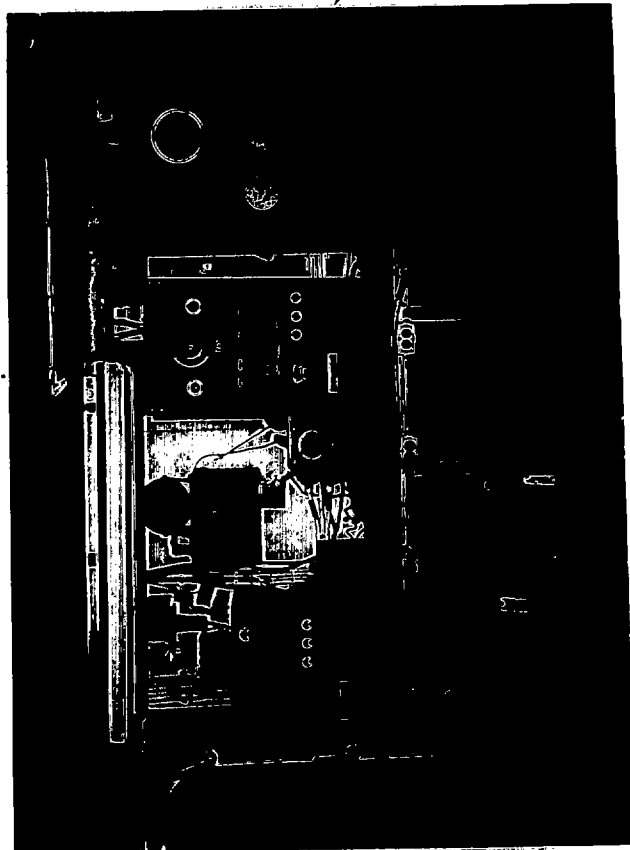

Rack 5
Clock A

Precision Clock Unit A

1. 1 kc Test Oscillator
2. 1 kc Automatic Starting Device
3. RBC Receiver for 1 kc tone
on 5560 kc

1 kc Tone Monitor Oscilloscope

Interlab Intercommunications

Heiland Recording String
Oscillograph

Top: Timing Tone Monitor Speaker

Middle: Receiver for 1 kc Tone
on 140.58 mc

Bottom: RBC Receiver for Audible
Monitor of Timing Signals;
4435 kc.

Figure 4. Timing Control Laboratory; Inboard Wall
(Note: Equipment in each rack is listed from top to bottom)



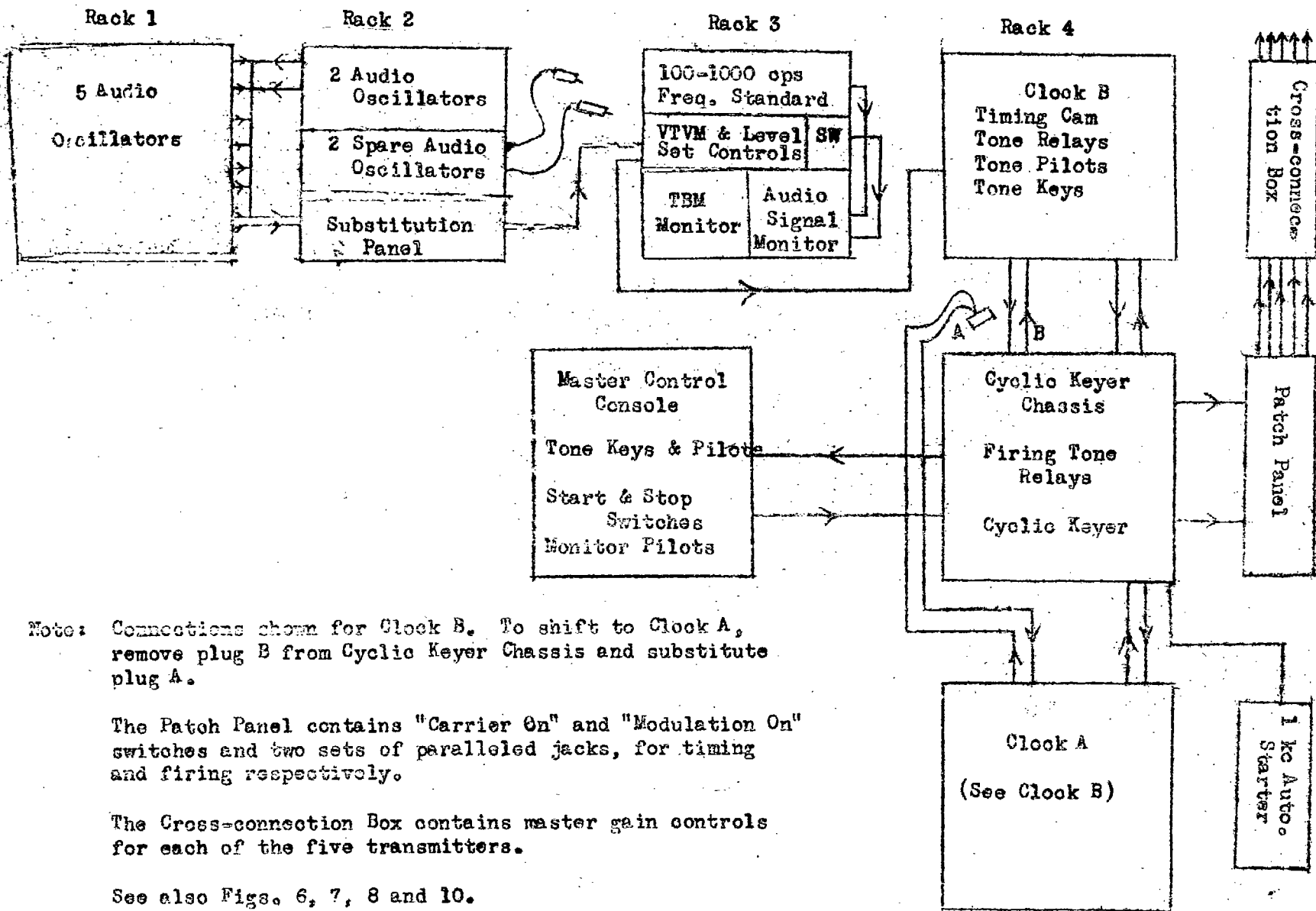

Note: Connections shown for Clock B. To shift to Clock A, remove plug B from Cyclic Keyer Chassis and substitute plug A.

The Patch Panel contains "Carrier On" and "Modulation On" switches and two sets of paralleled jacks, for timing and firing respectively.

The Cross-connection Box contains master gain controls for each of the five transmitters.

See also Figs. 6, 7, 8 and 10.

Fig. 5. Block Diagram of Timing Control Modulation System

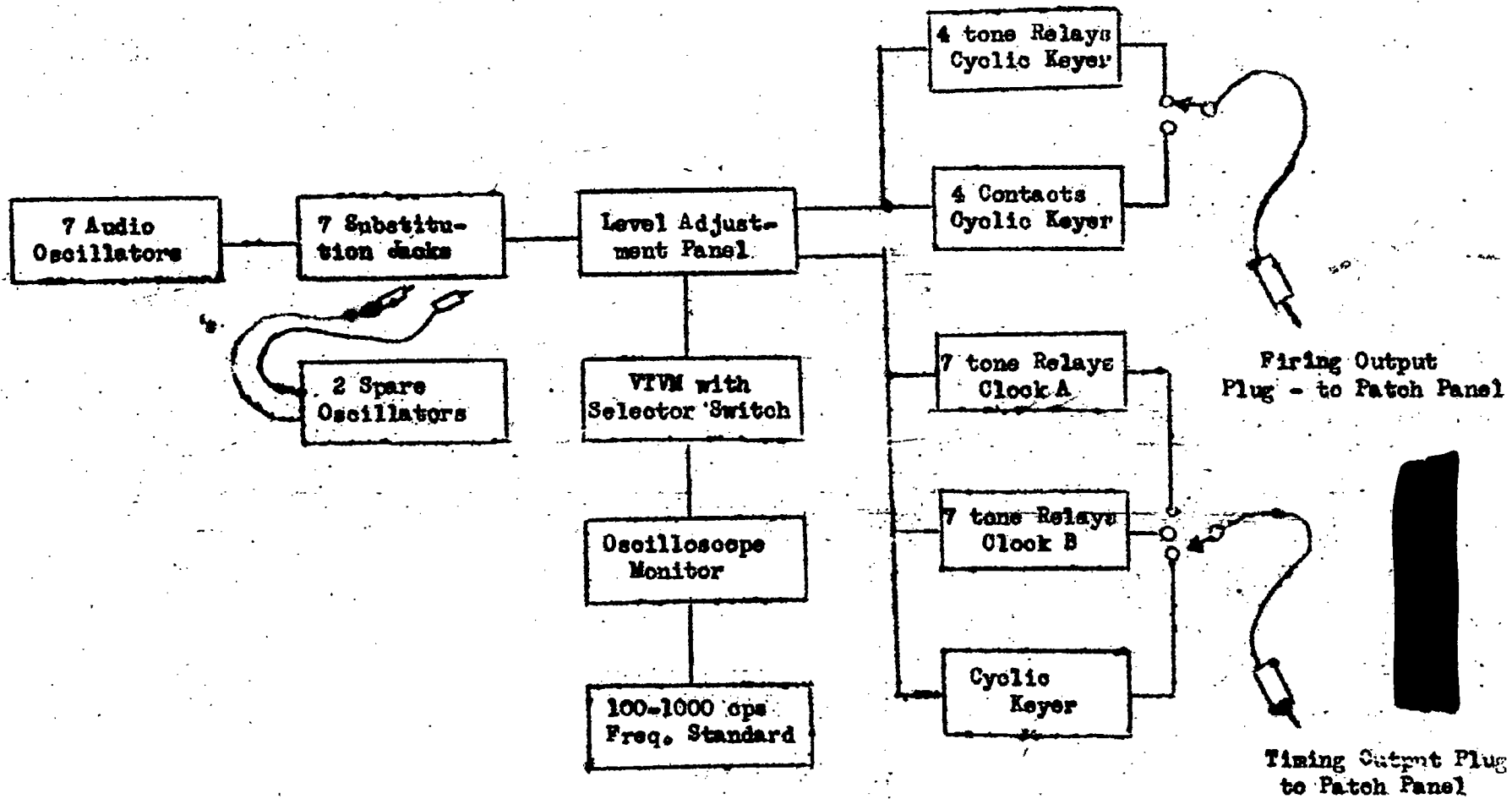

FIG. 6. Block Diagram of Modulation Equipment

[REDACTED]

one of the audio voltages to a Hewlett-Packard vacuum-tube voltmeter and also to a monitoring oscilloscope mounted lower in the rack. The horizontal plates of the oscilloscope were connected to a Hewlett-Packard 100-1000 cycle frequency standard, so that precise oscillator frequencies could be established by observing the Lissajous Figures. The frequencies were set to 0.1% or better, and were found to stay constant to 0.3% over long periods.

2.3.4. Keying System

Figure 7 shows the complete circuit from oscillator to modulator for a typical timing tone. It will be noted that there are two basic methods of keying the tones into the modulators. In the first method, there are 11 relays, for each of the timing and firing tones. Closure of one of these relays, whose energizing circuits will be considered later, puts the corresponding signal into the modulators. In the second method, there are pairs of cam-operated switches for each tone; these are closed automatically in sequence by a motor-driven cam that completes its cycle once a minute. This cyclic keyer is used for the preliminary testing. It can be seen that either type of keying can be selected for either group of transmitters independently. As will be shown later, where a single frequency is used for both timing and firing, the coils of the two relays are connected in parallel, so that the operation of a single switch modulates all transmitters simultaneously.

Under the operations plan, if, for any reason, it was desired to postpone the explosion for a period greater than a half-hour, but less than a day, it would be required to recycle timing boxes. At the same time, the bomb was not to be disarmed, since this would require a trip to the bomb-carrying barge, rearming by radio being impossible. Such a trip would result in a full day's delay. Therefore, a spring-return

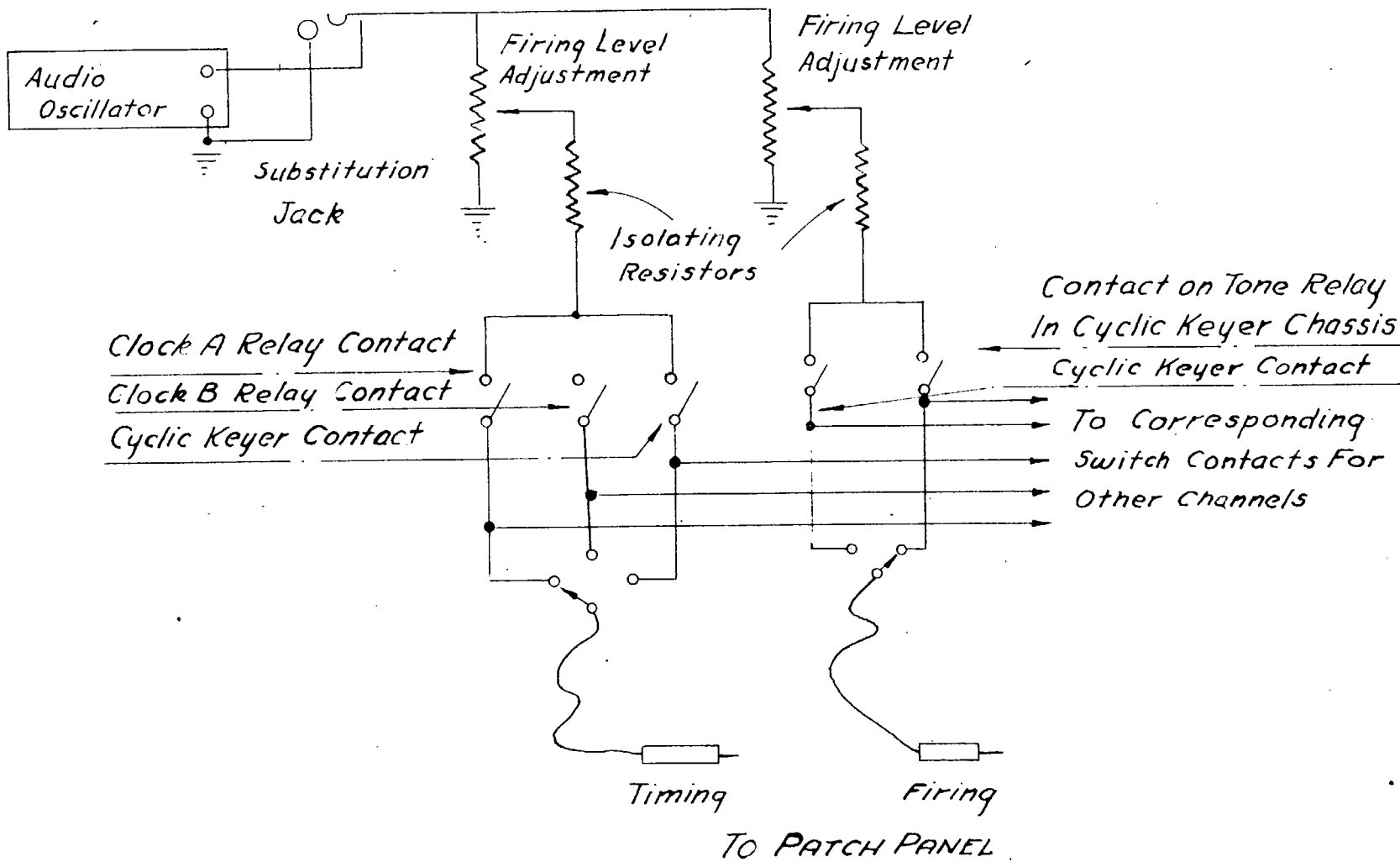

CIRCUIT OF TYPICAL AUDIO CHANNEL

FIG. 7

normally opened, switch was put in series with the disarm tone relay coils to prevent accidental disarming. To disarm, then, this switch had to be depressed while the "disarm-recycle" key on the control console was pressed.

Most of the interconnections among the various relay racks and the control console were made in the chassis mounting the cyclic keyer, and from this chassis emerged two cords terminated in phone-plugs, carrying the signals to the modulators. The plugs were inserted into jacks in rows of multiple jacks, so that from the multiple rows, patch-cords could connect to the several modulators in parallel, as shown in Fig. 8.

Because of the low input impedance of the modulators, the voltage at the patch panel varied with the number of modulators in parallel. Therefore, once the system was set up, the three firing transmitters were always left in parallel, and the timing transmitter was put in parallel with the spare. Audio voltages were then set for these loads. As was mentioned earlier, the modulation switches on the patch-panel were arranged to substitute an equivalent resistor in the "modulation off" position, so that transmitters could be turned on or off at will without disturbing the voltage levels.

It was found that the speech gain controls on the modulators were very coarse, changing gain in fixed steps of from 10 to 20%. Therefore, smooth gain controls were installed in the timing control lab, just above the patch panel. While these controls were not mutually independent they were nearly enough so that once the approximate settings were found, small corrections could be made readily. With these controls, the overall speech gains of all transmitters, were made equal and any trans-

FIG. 8

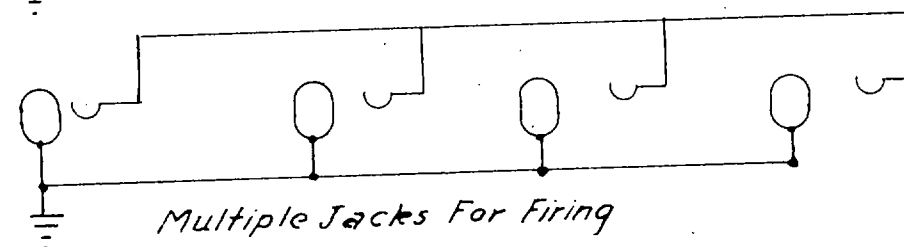
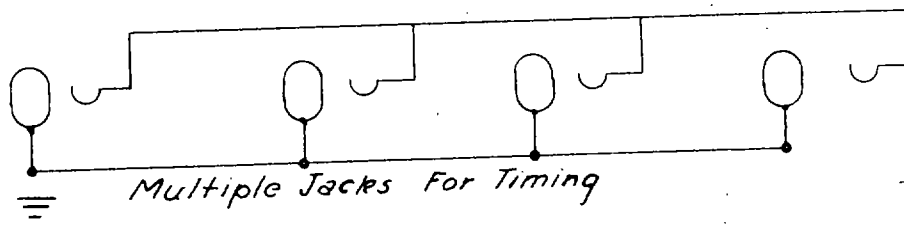
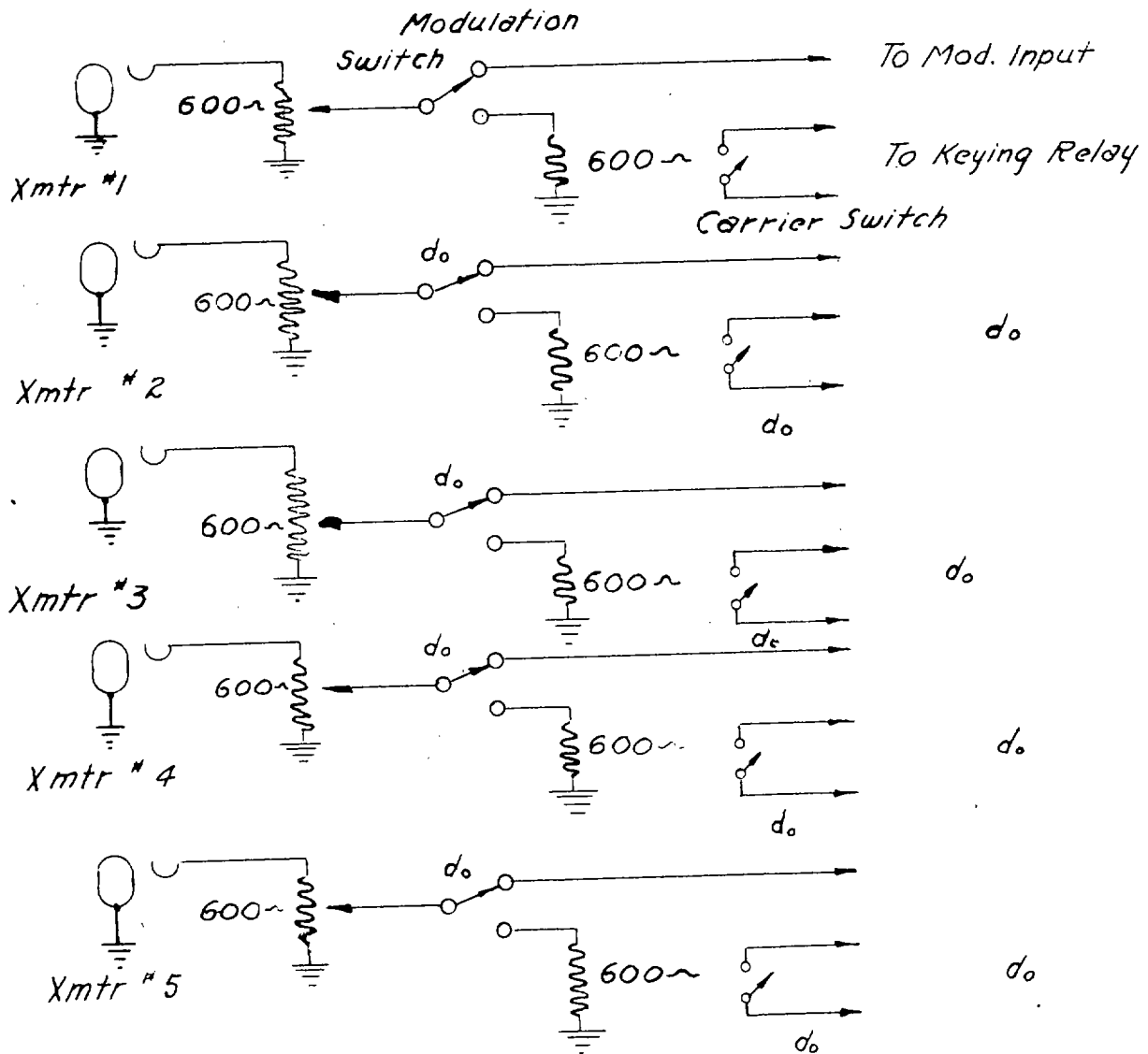

PATCH PANEL & CROSS CONNECTION BOX

mitter could be substituted for another by simply retuning and changing the modulation patch-cords.

Since, for a given audio input voltage, the percentage modulation depends on R-F carrier power output, all transmitters were loaded to a fixed power: 200 ma in the power amplifier plate circuit. For firing, a fixed figure of 90% modulation was selected for each tone used. Variations in receiver fidelity and filter-unit sensitivity were offset by gain control adjustments on each individual channel in each filter unit. Similar adjustments were not incorporated in the timing boxes and the variations in channel sensitivities were compensated for by varying the percentage modulation with frequency. It was found that the filter transmission increased with frequency by about 2 db for filters from 300 to 1630 cps, while the SCR-694-C receivers used in the timing boxes had a maximum response at about 850 cps. The percentages shown in the table below were found to give excellent compensation:

| Channel | -30 m | -2 m | -20 sec | -5 sec | -2 sec | Recycle |
|----------------------|-------|------|---------|--------|--------|---------|
| Frequency | 1150 | 610 | 300 | 850 | 420 | 1620 |
| % Mod | 42 | 42 | 56 | 38 | 45 | 90 |
| Filter input voltage | 2.7 | 2.4 | 2.2 | 2.5 | 2.3 | 2.8 |

It should be noted that this method of compensation results in the mid-band channels being particularly sensitive to possible operation by static crashes or other extraneous signals.

2.3.5. Timing Clocks

The operations plan for Test Able called for the manual keying of the -30 minute and the -2 minute tone signals at times based on the bombardier's voice announcements. The remaining three tones:

[REDACTED]

-20 seconds, -5 seconds, and -2 seconds were to be keyed automatically by the Hathaway Clock, (Fig. 9) which was to be started by the break of the 1 kc tone. All seven tone relays (including the "Zero tone" for shot Baker) were built into the clock, and seven push-buttons on its front panel could be used to close them. Leads from these push-buttons were brought over to the master control console, so that the relays could likewise be operated from there. Also in parallel with four of the push-buttons (the last three timing times and the "zero" time) were microswitches operated by a cam in the automatic clock. The relay energizing connections are shown in Fig. 11. This cam was arranged to make one complete revolution in 60 seconds, and then stop. As it swung around, it closed each of the micro-switches in turn for about 1.7 seconds. The cam was driven by a 1 rpm synchronous motor operating from a 60 cps 115 volt source built into the clock. This source consisted of a precision tuning fork oscillator and a power amplifier, and was accurate to within 3 seconds a day. The micro-switches were attached to a large frame which could be rotated to adjust the interval between starting and the "zero tone". A large dial engraved at $\frac{1}{2}$ second intervals and a vernier indicator made it possible to adjust this interval to within $\pm .03$ seconds, although certain eccentricities made it necessary to recalibrate the system when the interval was changed by a large amount. In addition to driving the cam, the precision source was also used to drive "local time" clocks on the automatic clock panel and at the control console, "Seconds-to-go" clocks at the same locations, and a recording chart to register the exact times at which the tones were sent out. The time intervals between the starting of the cam and the keying out of the tones depended on the exact position at which the cam came to rest after the cam tripped a stopping micro-switch. This position was found to vary by ± 0.1 second from cycle to cycle because of variations in the amount

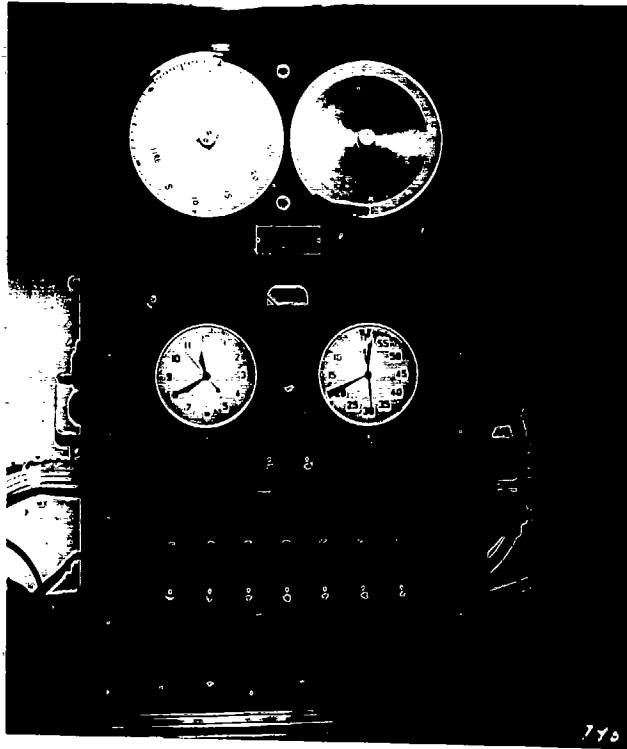

Figure 9. Hathaway Automatic Timing Clock

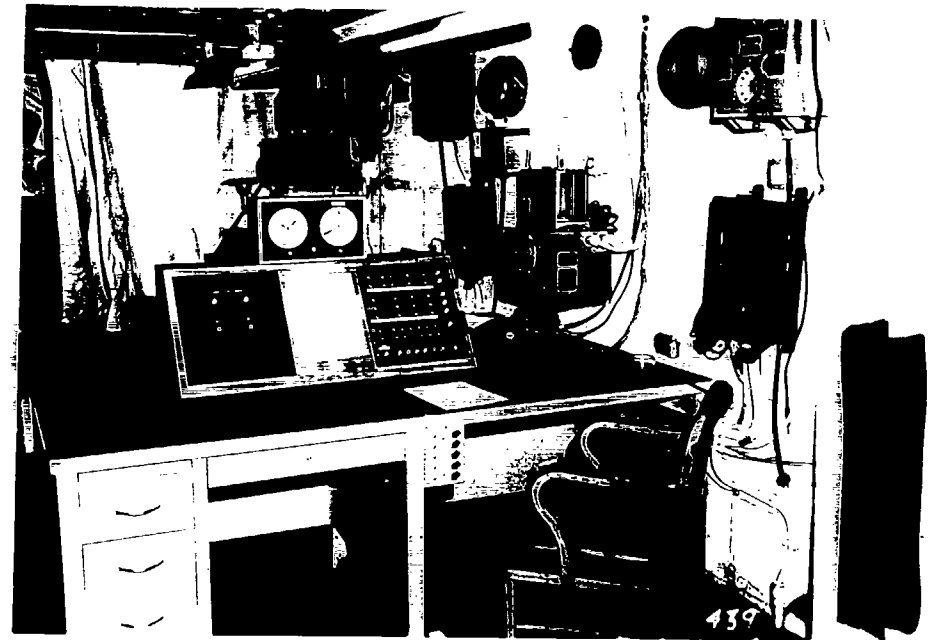
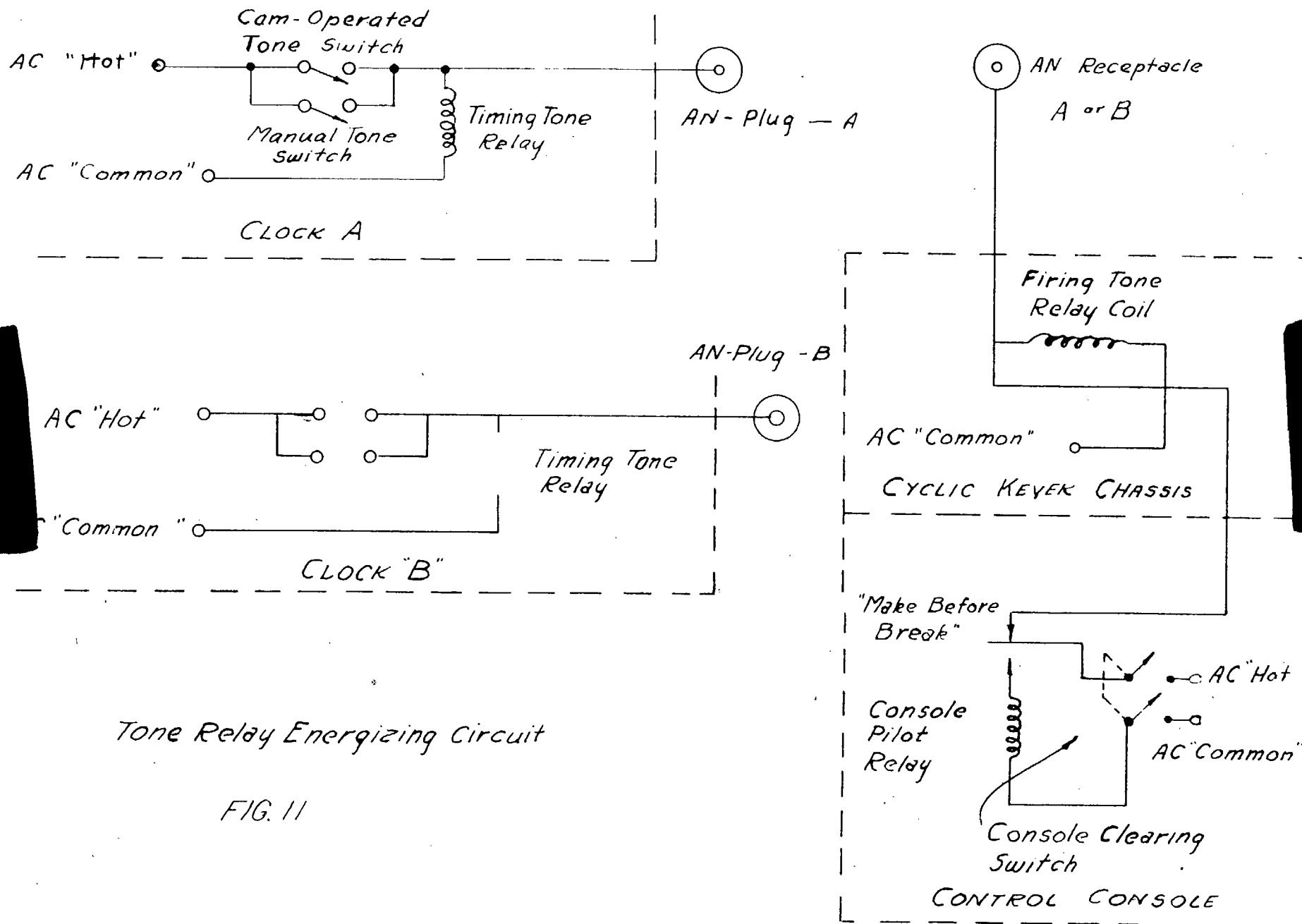

Figure 10. Master Control Console

The Gamma-Timing Equipment is located behind the curtain in the left background.



Tone Relay Energizing Circuit

FIG. 11

[REDACTED]

of coasting after removal of the power. Therefore, an electrical brake was incorporated. As the cam motor relay, (K-1 in DWG, C-31295 of the Hathaway Instruction Book) opened, 28 volts dc was switched across the cam motor. This reduced the coasting from 1 second to about 0.1 second, and the variability from 0.2 sec to an unmeasurable amount. A second change to improve the accuracy was to rewire the recording chart motor to run continuously instead of starting, with variable acceleration; simultaneously with the cam. A starting mark was then placed on the record from a set of contacts on the auxiliary starting relay in the cyclic Keyer chassis. It was found that the records thus produced were not strictly accurate, variations up to 0.06 seconds being noted when record were made on both clocks simultaneously. This was due either to non-uniform angular velocity of the chart itself, or to imperfect engraving. It was overcome by putting time markers on a blank chart, using a synchronously driven marker cam that put out "pips" at 1 second and 0.2 second intervals. With these changes, the intervals became constant and determinable to ± 0.03 seconds.

The mechanical resetting mechanism, which had to be pressed after each cycle before a fresh start could be made, was suspected of causing errors due to the spring forces exerted on the cam. It was replaced by an electrical reset - a relay, K-2 which bridged across the stopping micro-switch until the cam had passed its roller. It was found that occasionally relay K-2 could drop out and release the starting relay K-1 during the brief interval between the opening of one set of contacts and the closing of the other of the SPDT micro-switch. The consequent stopping of the clock, however, could be avoided by keeping the console starting button depressed for at least 3 seconds. In this case, the auxiliary starting relay in the cyclic keyer chassis bridges the gap. Care had to be taken to release the switch before the first

tone was keyed if a chart record was desired, otherwise the auxiliary starting relay held the stylus up and obliterated the records of the tone relays.

The manner of connecting the two clocks into the overall circuit was complicated by the necessity of conserving cable wires and connecting pins, which became scarce as extra features were added. Most of the relay coil circuits, the clock starting and stopping circuits, and the precision source circuits were interinvolved so that it was necessary to keep very close track of the two sides of the primary line, to avoid short-circuits when power plugs were reversed, etc. Finally, it was arranged to bring all power into Clock B, from which it was distributed to Clock A, the cyclic keyer, the control console, and the automatic starter. Similar precautions were used for the 28 volt d.c. line, one side of which was grounded at the generator.

Most of the interconnections among the various units were made inside the cyclic keyer chassis, which also contained four tone relays for keying the firing transmitters. One cable connected it to the audio oscillator VTVM rack, and another to each of the clocks, carrying the audio tones in and out as well as the starting and stopping connections. The 28 volt d.c. and the 115 volt primary power were carried in on these cables. An additional cable ran to the particular clock selected for use. It carried the precision voltages for the clocks on the control console and the energizing power for the tone relays. Switching from one clock to the other then was accomplished by removing the cable from the one clock, and plugging in the corresponding cable from the other, followed by throwing the switch on the cyclic keyer chassis to select the proper audio output line. This switch

[REDACTED]

had a third position in which the modulators were connected to the cyclic keyer contacts.

A similar switch was provided for the firing transmitters, but this had only two positions: Clock and Keyer. The Clock position connected the line to the four tone relays in the keyer chassis; these derived their energizing power from the clock selected through the removable cable.

The direct starting mechanism of each clock was a relay in the clock chassis, with contacts in the cam motor circuit. This relay could be energized by pressing a switch on the clock, and de-energized either through the action of the stopping microswitch, at the end of the cycle, or by pressing a stopping switch on the clock chassis. To start and stop both clocks in synchronism, an auxiliary starting relay was provided in the cyclic keyer chassis, with contacts in parallel with each of the individual clock starting switches. This relay also had two pairs of contacts for operating the recording chart stylus, to give a mark for the starting time. It was energized either by a starting switch at the control console, or by the closure of contacts on a relay in the automatic tone-break starting device. Stopping circuits to unlock the clock starting relays were brought out from each clock to the control console, but separate by-passing switches were provided that made it possible to operate either clock independently, even with the cables to the console unplugged.

2.3.6. Automatic Starting Device.

Figure 12 is the circuit of the filter chassis of the automatic starting device. Fundamentally, it is a filter-amplifier-relay unit similar to the ones used as transmitter monitors. It is provided

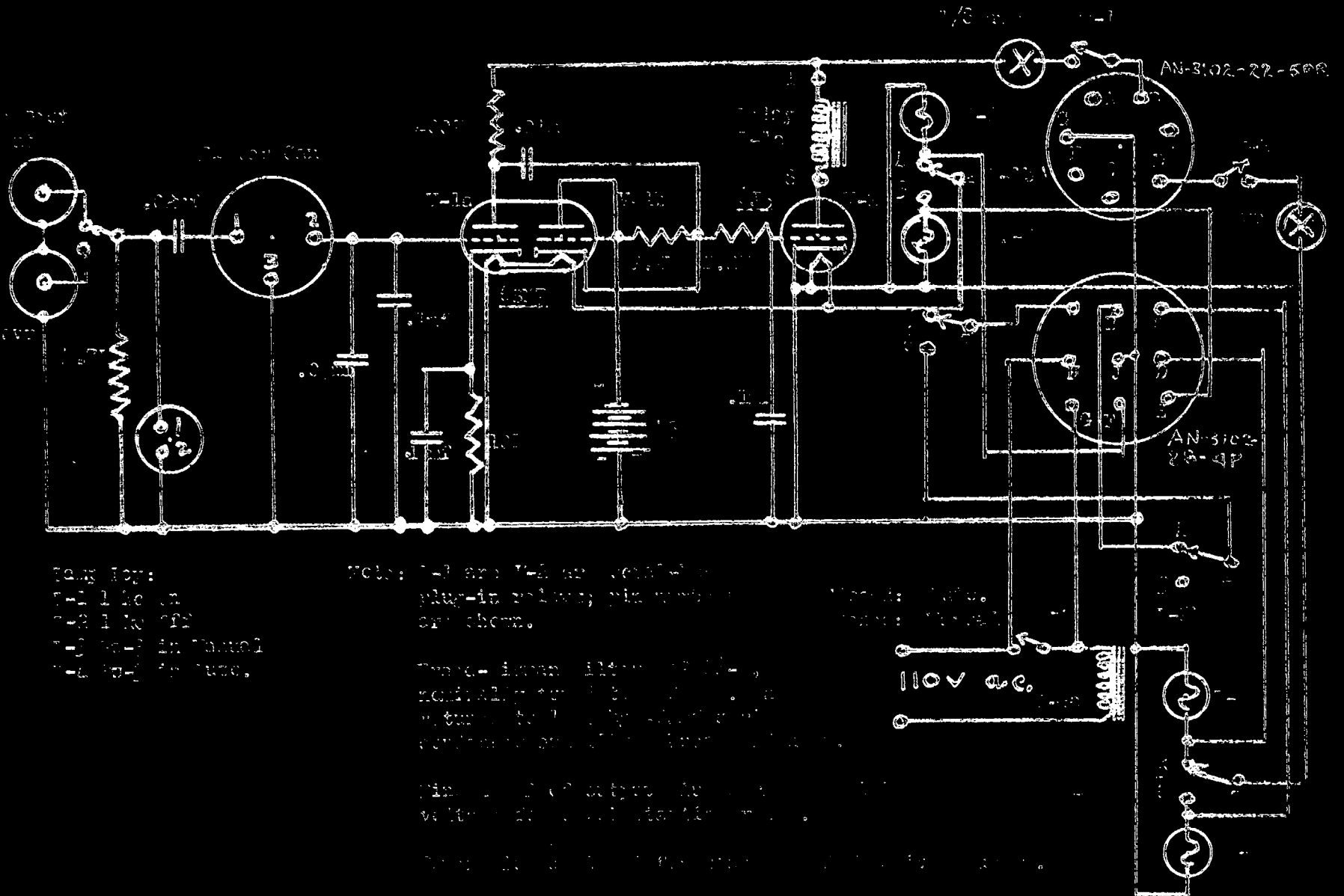

Notes:
1. The 7-10 tube is a 6X4 tube.
2. The 7-15 tube is a 6X4 tube.
3. The 7-16 tube is a 6X4 tube.
4. The 100V AC source is a 100V AC source.

Notes: 7-10 and 7-15 are 6X4 tubes.
7-16 is a 6X4 tube.
plug-in relays; pin numbers are shown.

7-10 - 100V AC source.
7-15 - 100V AC source.
7-16 - 100V AC source.

pin numbers are shown.
with 100V AC source.

Fig. 12. Automatic Starting System.

[REDACTED]

with switches and relay contact connections such that when the "automatic-manual" switch is in the "automatic" position, voltage for the starting relay is provided through the filter-unit relay contacts. When, due to a 1 kc. signal, this relay is operated, this starting circuit is opened, but the break in the tone causes it to close, and permits the clock to start, unless the circuit is interrupted as a result of the switch being in the "manual" position. During normal operation, then, the switch is left in "manual" until the 1 kc signal is received. Then it is thrown over to "automatic", and the clock starts as soon as the tone is broken.

2.3.7. The Control Console.

The master control console is shown in Figures 10, 13, 14. It consists of three panels, one with clocks, one with indicator lights and switches for the keyed tones and the repeat-back circuits, and one with the starting mechanism.

The left-hand clock shows local time, for each test it was set accurately with the ship's chronometer. The right-hand clock starts when the cam-motor in the automatic clock chassis starts, and indicates the number of remaining seconds before the expected explosion time. On the back of this part of the console, not shown, is a second "local time" clock.

The indicator lights in the right-hand panel (Fig. 14) are grouped into rows according to function and columns according to time. The upper two rows are the indicator lights for the repeat-back system. From left to right, they are: spare, generators on, X-unit charged, armed, and fired. The white lights at the right of this and the other rows indicate that the various units are turned on.

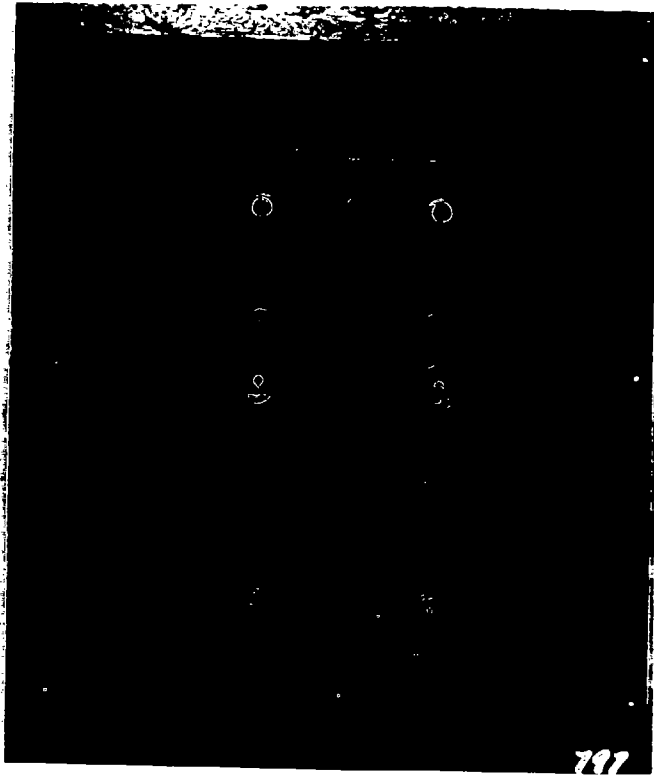

Figure 13. Control Console - Left Panel

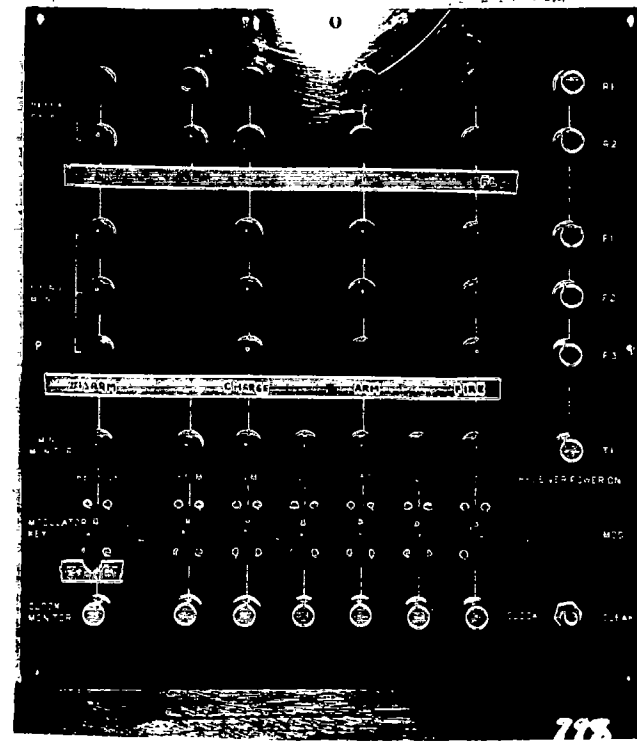

Figure 14. Control Console - Right Panel

[REDACTED]

The next three rows of lights, which are red, are the monitor lights for the three firing transmitters. These light up only when the corresponding tones have actually been transmitted. The left-hand light is for the disarm tone; the next three are charge, arm, and fire, respectively. Since these operations occur at times used for timing purposes, and are carried out with the same audio frequencies, they are therefore placed directly over the corresponding timing monitor lights.

The sixth row contains the green timing monitor lights. From left to right, they are: recycle, -30 min., -2 min., -20 sec., -5 sec., -2 sec., and "fire". Below this row are the seven keys which energize the tone relays in the clock chassis and the cyclic keyer chassis. When thrown upward, they will remain on, but when thrown downward, they will be returned by spring to the neutral position as soon as the pressure is released.

Below the switches is a row of white indicator lights which merely indicate that the corresponding keys have been thrown. These also light up when the tone-circuits are closed from the clock, either by pressing one of the keys there, or through the action of the automatic timing cam. They work from relays mounted on a chassis inside the console cabinet, which are provided with locking contacts so that these lights remain lit until cleared by pressing the clearing push-button at the extreme right end of the row.

The left-hand panel, (Fig. 13) of the control console has a switch at the top that was originally intended to select the clock used. It was found to be too difficult a problem to switch the many leads required in changing from one clock to the other, ~~so~~ this switch was not used, except as a reminder, by lighting the corresponding pilot, as to which clock was plugged in. Below this switch are the pilots which indicate whether or not the clock cam motor is running, and switches to start and to stop it. Still lower, are lights that indicate whether

[REDACTED]

or not a 1 kc tone is being received; this helps the operator decide at which time to throw the automatic starter switch from "manual" to "automatic". At the bottom is the "automatic-manual" switch, and lights to show which position it is in. These last four lights and the switch are duplicated on the automatic starter chassis.

2.3.8. Repeat-Back Link

A detailed description of the repeat-back link is given in the firing signals report.

III. THE TIMING UNITS

3.1. Function

The purpose of the Timing Box was to make possible the remote operation of such devices as cameras, blast recorders, and various kinds of measuring instruments. This was to be accomplished by the closing of switches at certain time intervals prior to the moment of the bomb's explosion by a sequence of radio signals.

3.2. General Description

The Timing Box consists of a six tube superheterodyne receiver, a special filter-relay unit, a spring wound clock, batteries capable of operating unit for 50 hours, an antenna and a waterproof wooden box to house these components (see Fig. 14A).

It was the function of the Timing Box to receive the signals transmitted from the AV-17, separate modulation frequencies with audio band-pass filters, amplify and rectify to make them operate relays. After a relay had been closed by a suitable audio signal, an electrical holding circuit was provided to keep it closed. The relay contacts in the timing box were not guaranteed to hold during the explosion and therefore it was recommended that some shock-proof system be incorporated in the external instrumentation to lock circuits closed after the last required timing signal had been received.



Fig. 14 A - Timing Unit

[REDACTED]

The audio modulation tones and the corresponding time intervals are given in the table below:

| <u>Time interval prior to explosion</u> | <u>Frequency of Audio Signal</u> |
|---|----------------------------------|
| 30 min. | 1150 c.p.s. |
| 2 min. | 610 c.p.s. |
| 20 sec. | 300 c.p.s. |
| 5 sec. | 850 c.p.s. |
| 2 sec. | 420 c.p.s. |
| <u>Recycling Signal</u> | <u>1620 c.p.s.</u> |

The standard Timing Box could be arranged to respond to any three of the available time intervals. Boxes that contained either a 30 min. or a 2 min. channel were supplied with a recycle channel. This was necessary, particularly in Test Able where the decision to drop the bomb might not have been firm until after the 30 min. and 2 min. relays in the Timing Box and also opened a set of normally closed relay contacts which could be used to interrupt an external circuit.

3.3. The Timing Unit Components.

3.3.1. Receiver

The S.C. R. 694 receiver was selected for use in the Timing Box because it satisfied all of the requirements for the job at hand. This receiver covered the desired frequency band and it could be operated with dry batteries. The power consumption of the receiver is extremely low, thus permitting suitable battery life. Reports from Naval Research Laboratory on its performance were favorable. The immediate availability of the SCR 694 was also a large factor in the selection, because of the volume of boxes to be produced within a short period of time. The receiver circuit diagram is given in Fig. 15. The SCR 694 was only available as a complete unit, i.e; receiver and transmitter. The metal shell housing both the transmitter and receiver,

IDENTIFICATION OF RADIO RECEIVER AND TRANSMITTER BC-1306

- 27 Resistor, carbon, 33,000 ohm
- 28-1 Resistor, carbon, 100,000 ohm
- 28-2 Resistor, carbon, 100,000 ohm
- 28-3 Resistor, carbon, 100,000 ohm
- 29 Resistor, carbon, 47,000 ohm
- 30 Resistor, carbon, 10 megohm
- 31 Resistor, carbon, 1 megohm
- 32 Resistor, carbon, 1 megohm
- 33 Resistor, carbon, 60,000 ohm
- 34 Resistor, carbon, 1.25 megohm
- 35 Resistor variable, carbon, 1 megohm
- 36 Resistor variable, carbon, 1 megohm
- 37 Resistor, carbon, 270,000 ohm
- 38-1 Resistor, carbon, 25,000 ohm
- 38-2 Resistor, carbon, 25,000 ohm
- 39 Resistor, carbon, 500,000 ohm
- 40 Resistor, carbon, 30,000 ohm
- 41 Resistor, carbon, 2,500 ohm
- 42 Coil Assembly, antenna
- 43 Coil Assembly, R-f
- 44 Transformer, I-f
- 45 Transformer Assembly, I-f
- 46 Transformer Assembly, I-f
- 47 Coil Assembly, cal. osc.
- 48 Coil Assembly, beat freq. osc.
- 49 Transformer, audio output
- 50 Switch, HIGH-MED-LOW sensitivity
- 51 Switch, PHONE-CW-NET-CAL
- 52 Switch, output amp. (250 and 4000 ohms)
- 53 Switch, dial light
- 54-1 Jack, phone
- 54-2 Jack, phone
- 55 Jack, antenna connector
- 56 Jack, ground
- 57 Plug, male, 6 pin power
- 58 Voltage Reg. (selenium rectifier)
- 59 Socket, dial light
- 60 Socket, 200 kc crystal
- 61 Socket, R-f amplifier tube, 1L4
- 62 Socket, converter osc. tube, 1R5
- 63 Socket, 1st I-f amp. tube, 1L4
- 64 Socket, 2nd I-f amp. cal. osc. tube 1R5
- 65 Socket, diode audio amp. tube, 1S5
- 66 Socket, audio output tube

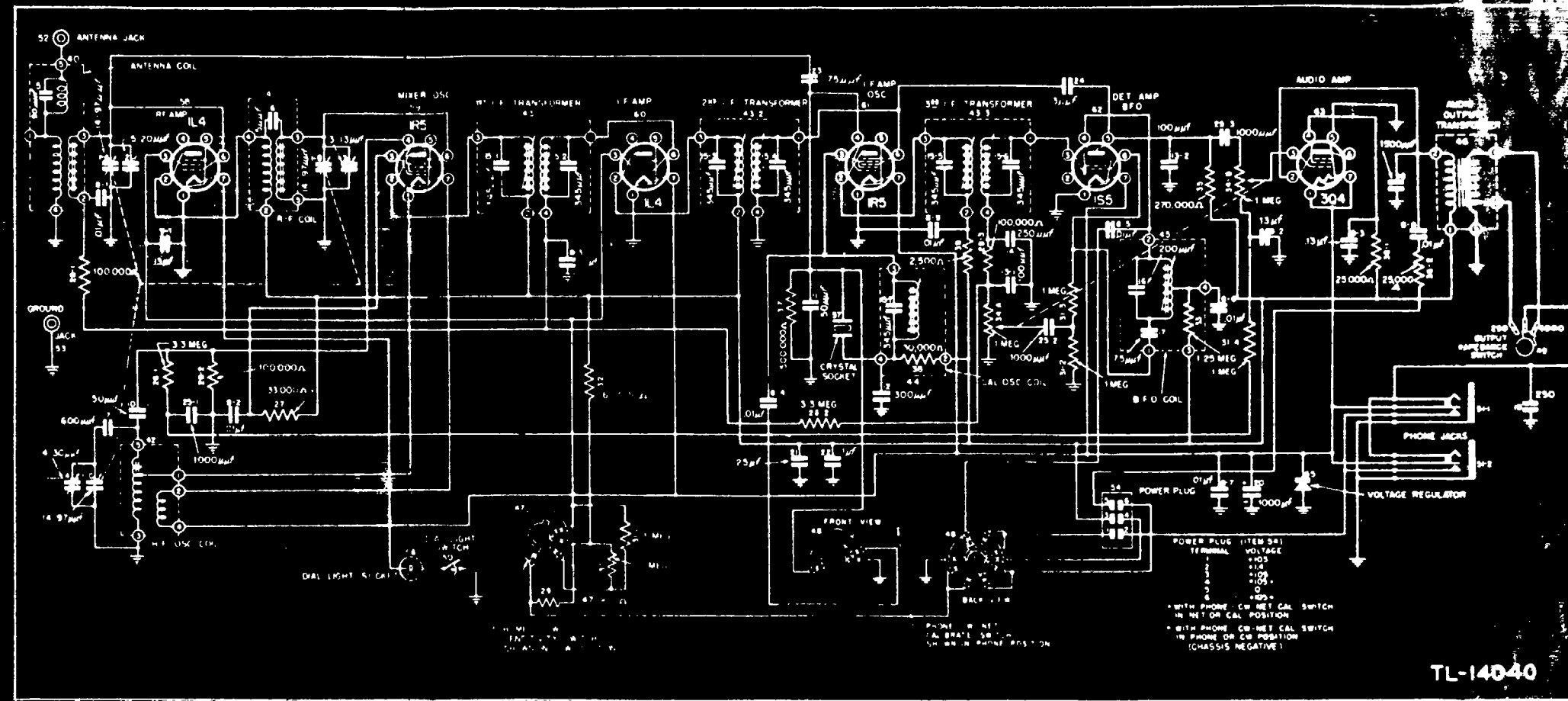

Figure 58. Schematic diagram, receiver of Radio Receiver and Transmitter BC-1306.

TL-14040

Fig. 15 - SCR 694 Receiver Circuit Diagram

was retained for use in the Timing Box. The transmitters were removed and returned to Naval stores. The space in the housing vacated by the transmitter, proved suitable to house the special filter-relay unit. (See Fig. 16). A small modification had to be made in the Jones plug connections in the transmitter-receiver housing, to accommodate the substitution of the filter-relay unit for the transmitter.

3.3.2. Filter-Relay Unit:

A search was made for a filter-relay unit that could be operated with low drain from portable type dry batteries. It was found that no such device was available from Government sources or on the commercial market. Therefore, it became necessary to design and produce the filter-relay units to be used in the Timing Boxes. The circuit used in the Filter-Relay Unit is a straight forward arrangement of a band-pass filter, an audio amplifier, a detector, and a D.C. amplifier controlling a relay. (See Figures 17 and 18).

Army-Navy surplus stocks were searched for suitable audio-filters, and Fredd type 12266 which had been used by the Navy in the ARW-2 radio controlled apparatus for drone planes, were located. There are ten filters in this series, #12266-1 to #12266-10, which cover the frequency range from 300 c.p.s. to 6000 c.p.s. Center frequency of each filter varies from the adjacent ones by factor of about 1.4. The band width of any one channel is about $\pm 10\%$ of the center frequency. Adjacent channel attenuation is approximately 20 D.B.

Since battery consumption was an important factor in selecting a tube for the circuit, the 1D8-G.T. was found to be suitable. It contains in one envelope a triode, pentode, and a diode. It was not possible

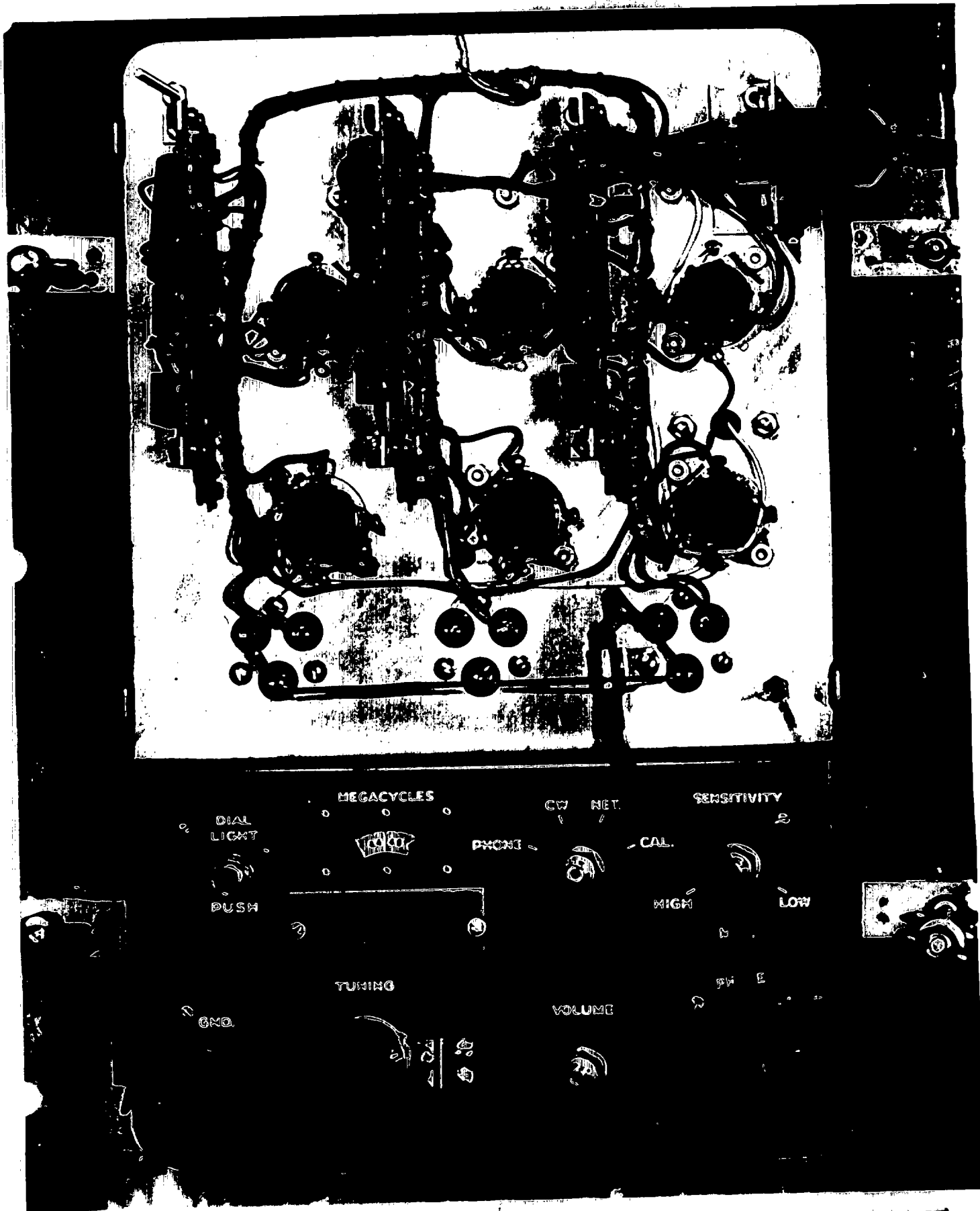

Fig. 16 - Receiver and Filter Unit
APPROVED FOR PUBLIC RELEASE



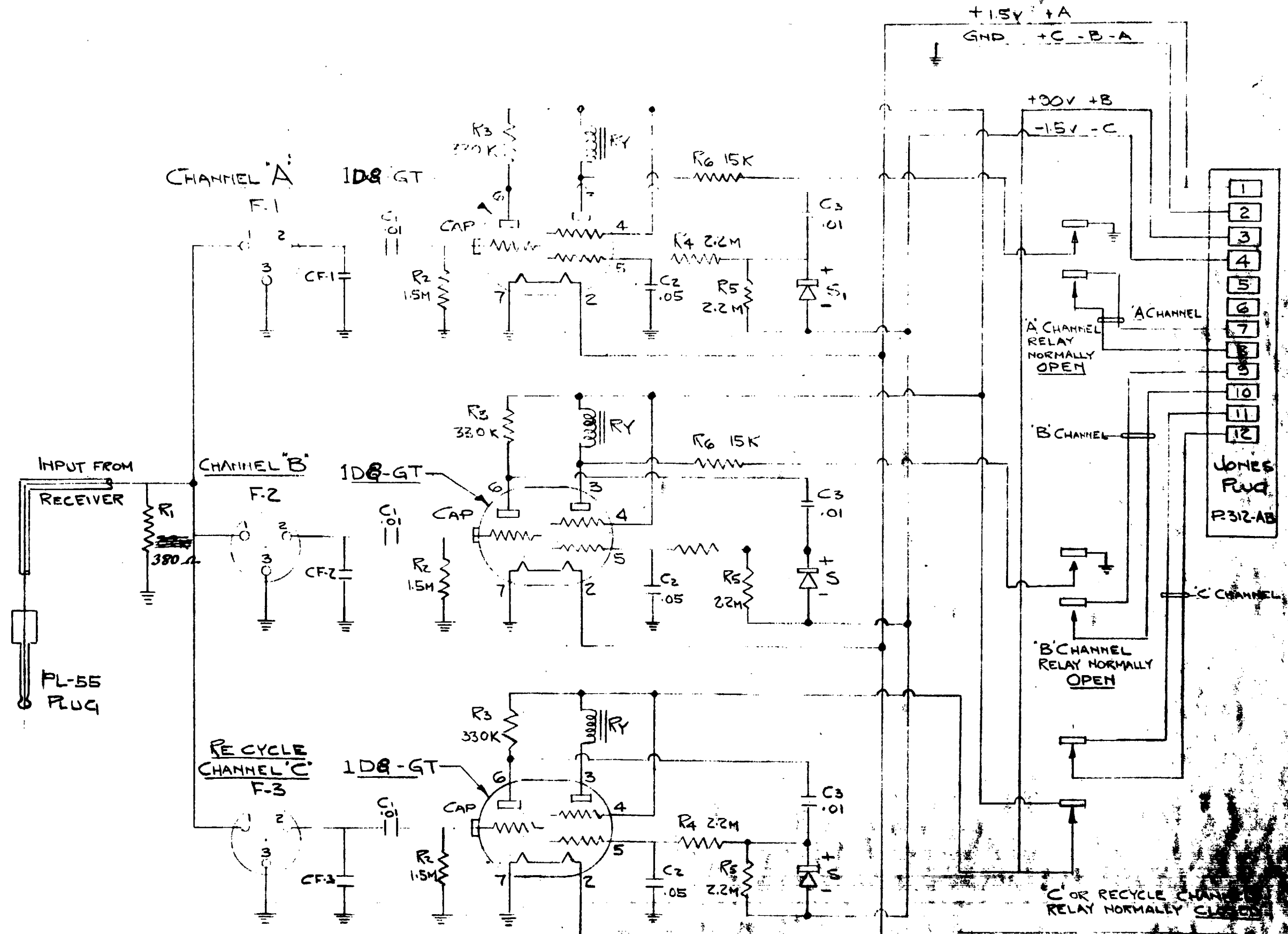

Fig. 17

NOTE - LOCKING FEATURE (R6) NOT USED ON CHANNEL C

+ TERMINAL OF S1 RECTIFIER IS INDICATED BY A SMALL RED DOT ON LEAD WIRE

SCHEMATIC WIRING DIAGRAM FOR FILTER UNIT



Fig. 18 - Filter - Relay Unit

to use the diode section of the tube as the detector since the filament is common to the other sections and is grounded. A selenium rectifier was used as the detector. Several types, ranging from two to eight elements, were tried in the circuit and all seemed to function properly. The four plate type was selected for use in the actual production of the filter-relay unit.

The relay selected was the Advance type 604-G13. This relay plugs into a standard octal tube socket. The plug-in feature was particularly desirable from the stand-point of testing and servicing. The relay's coil resistance is 4000 ohms. The power required to operate the relay is about 900 m.w. The nominal current required to operate the relay was 3.8 m.a., and the relay will reopen on a current less than 2.5. m.a.

3.3.3. Battery Supply

U.S. Army Signal Corp. Battery, Type BA-48, was used to supply the filament and plate voltages for the receiver and the filter relay unit. Two of these batteries were used in parallel. Two of these batteries would afford the complete Timing Box a period of 50 to 60 hours of continuous operation. The filament connections supply 1.5v and the "B" connections supply a potential of 90v. Overall size of BA 48 is 10" x 5" x 2". The "C" batteries used are the common type 7.5 volt units. They have taps at 1.5v, 3.0v, 4.5v, and 6.0v. Three of these were used, connected in series. Because their function in the circuit was simply to supply a bias voltage at no current drain their life was long.

3.3.4. Clock

Each box contained a spring wound clock which operated a microswitch that energized the receiver-filter unit. This clock made it possible to leave the box in an inert condition and have it turned

on just prior to the explosion period. This conserved battery life, and even more important, reduced the probability of prefiring on random signals. The clock mechanism rotated a notched dial once each 24 hours. The notch was cut to turn on the unit for a six hour period each 24 hours. The clock had a running time of approximately 50 hours.

3.3.5. Antenna

The antenna mast base and antenna sections supplied with the SCR 694 were used with the Timing Box. There are ten antenna sections, each about 3 ft. long, in one kit. This made possible a whip antenna from 3 ft. to 30 ft. in length. The porcelain insulated mast base included two rubber gaskets affording a water-tight fitting in the 3 inch hole in the top of the wooden box.

3.3.6. Waterproof Box.

Several qualifications were required of the box to contain the components of the timing apparatus. The box had to be sturdy, waterproof, and had to have a door providing access to the components. A pair of wooden legs were provided with each box. These legs were to be screwed to the bottom of the box to give it a firm foundation, and to elevate the bottom from the deck or ground. A circular hole, 2" in diameter, was cut in the top of each box to provide for the installation of the antenna mast base.

The cover or door on the box was supported by a metal hinge running the entire length of the box. When closed and compressed against the rubber gasket seated around the edge of the box, a water-tight seal was formed. A very sturdy type of construction was employed in joining the sides of the box. (See Fig. 19). The outside dimensions of the box are 30" x 20" x 10". The timing unit interval cabling diagram is shown in Fig. 20.

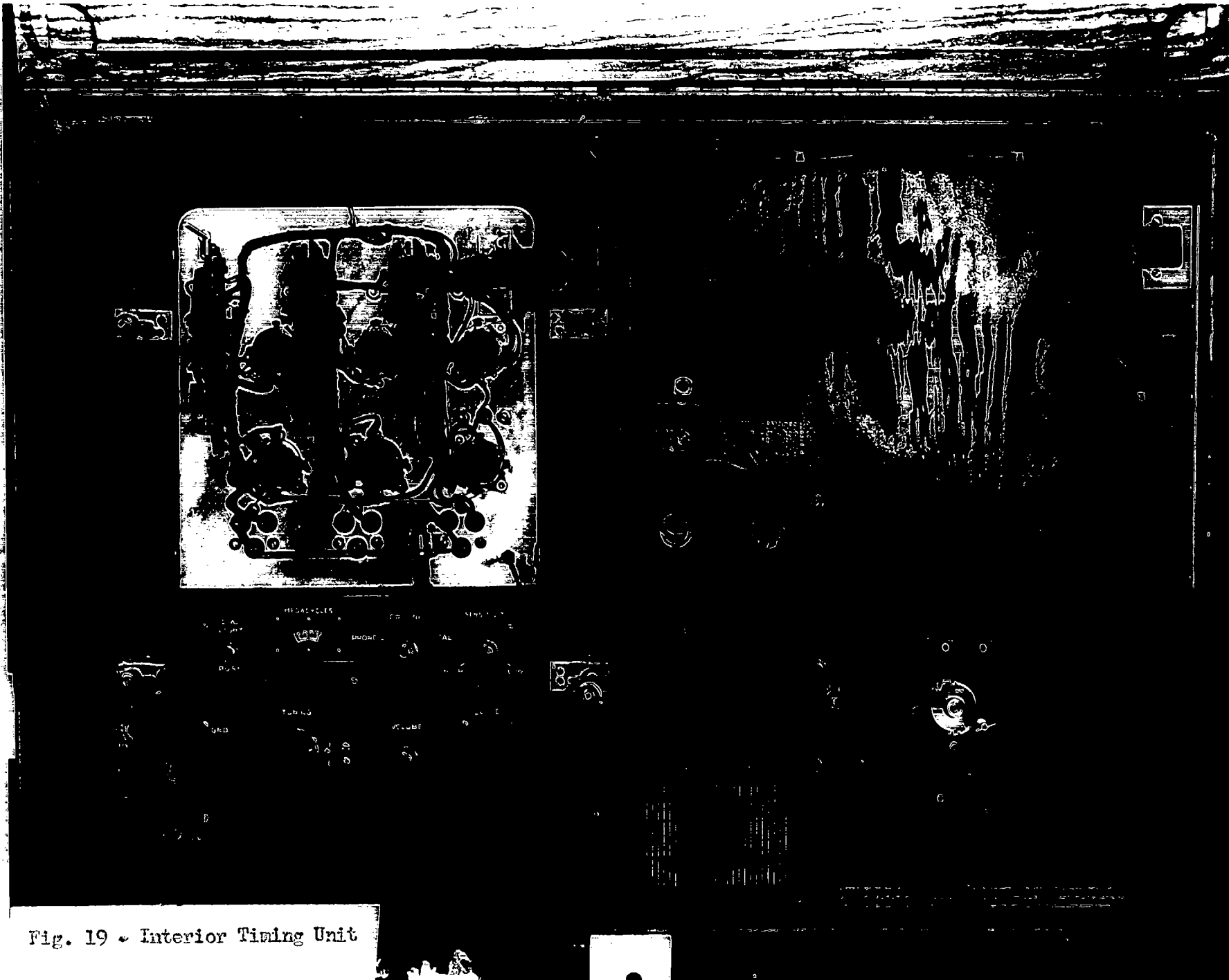

Fig. 19 - Interior Timing Unit

JONES S-312-CCT PLUG
PLUGS INTO FILTER UNIT

JONES S-312-AB PLUG
TEST PLUG

AMPHENOL AN-3102-24-2F
OUTPUT PLUG

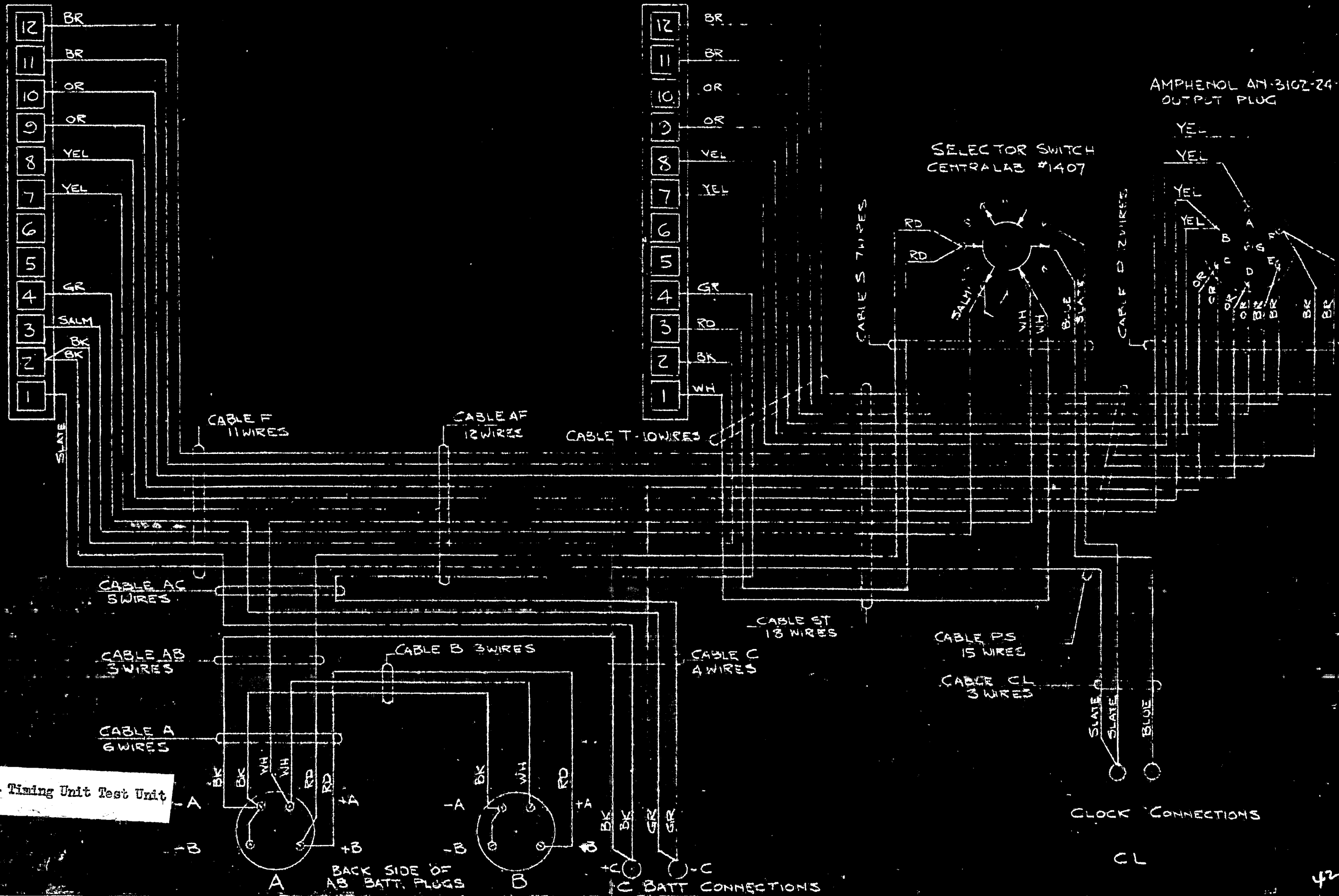

Fig. 20 - Timing Unit Test Unit

3.3.7. Timing Unit Test Box.

For purposes of testing Timing Boxes in the field, a small test box was designed. This test box consisted of a three range voltmeter to check battery voltages, and a set of three pilot lamps to indicate relay action. A cord 3 ft. long terminated in a 12 pin Jones plug for insertion in a test jack provided in the Timing Box. The box is also sturdy and water-tight. See Figures 20, 21 and 22.

3.4. Production Scheduling and Facilities.

The Timing Units were produced with the aid of the Terminal Island Naval Shipyard. The services of the Shipyard's Electronic Planning Dept., Design Dept., and all the shops were made available to the production of Timing Units. The Radar Repair Shop was selected for the location of the main assembly line to produce the Timing Units. A room approximately 40' x 30' was completely cleared and made ready for this purpose. (See Figure 24)

The total number of timing Units to be manufactured was fixed at 300. This figure allowed for an ample number of spares and for the possibility that few of the Test Able boxes could be used again in Test Baker. Procurement of components of the timing units, with the exception of the SCR 694 units, was handled by the Manhattan District, University of California Procurement Office. An agent of the Los Angeles office was assigned to work directly with the production group at Terminal Island and was of great value in expediting components. Over fifty separate items, some of which were extremely scarce, were needed for each unit. Those components available at Los Alamos were allocated for this use. A total of 55 clock manufacturers distributed all of the country, were canvassed before a suitable clock could be located. After designs had been frozen it was found that ID8-GT

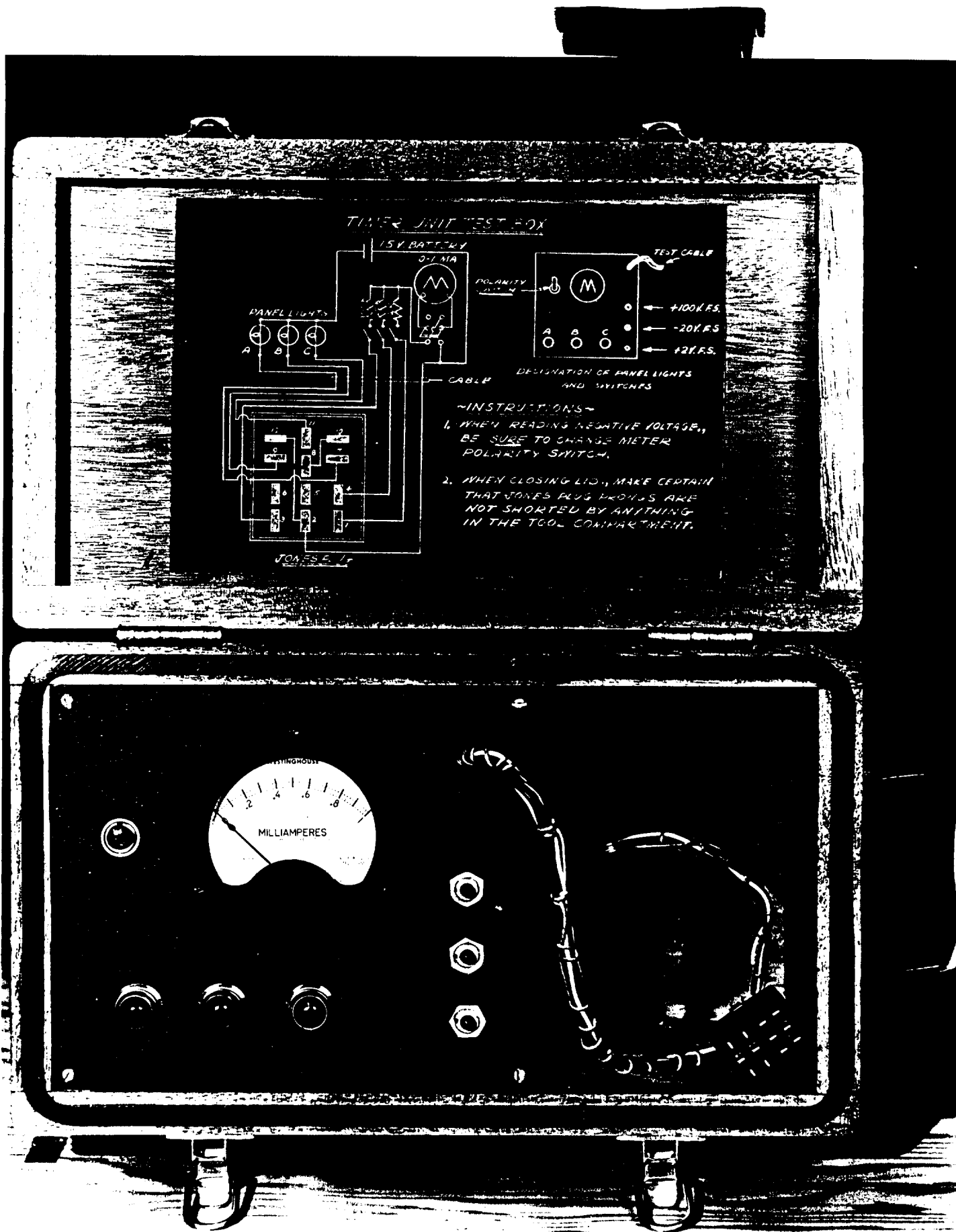

Fig. 21 - Test Unit Box

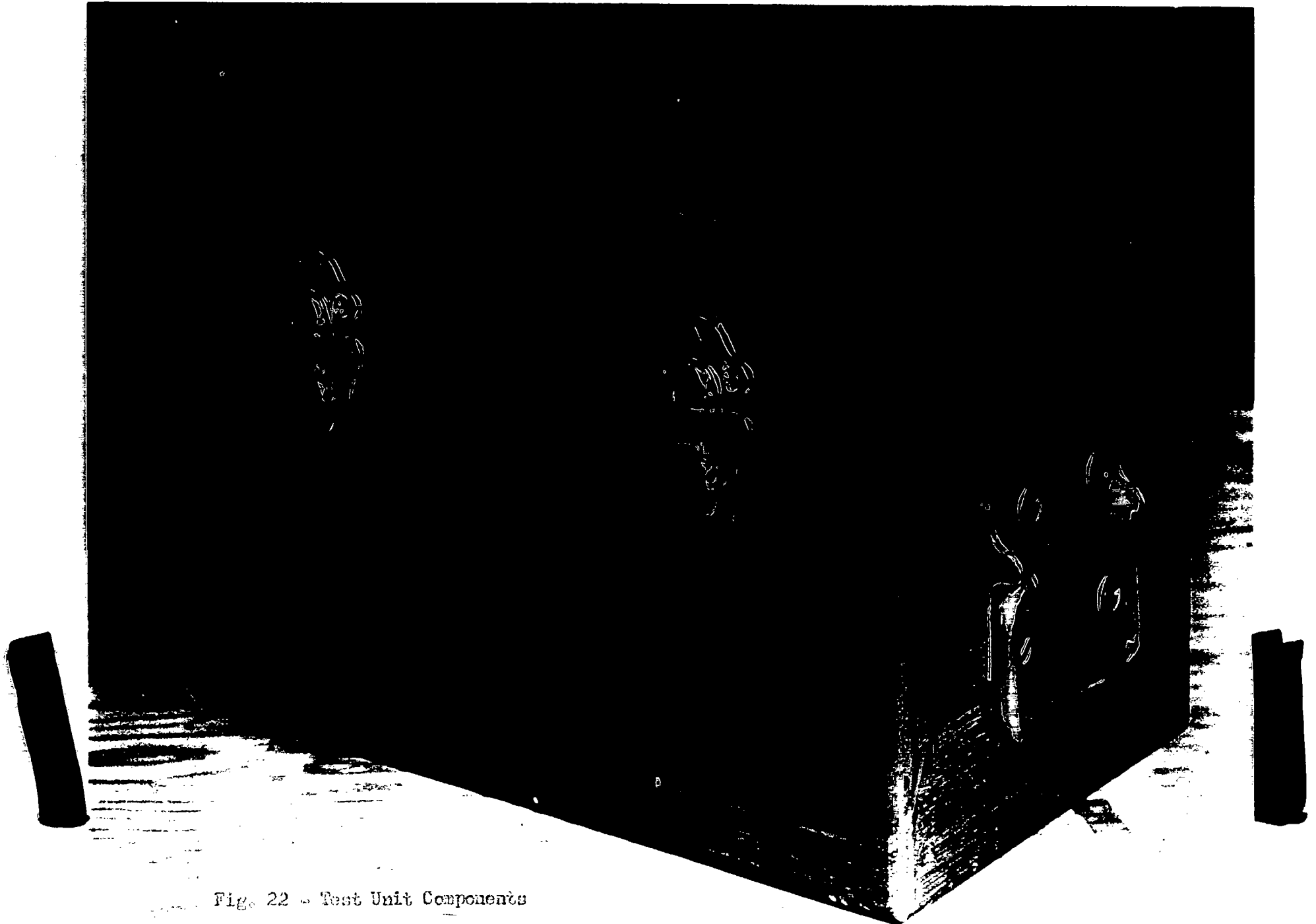

Fig. 22 - Test Unit Components

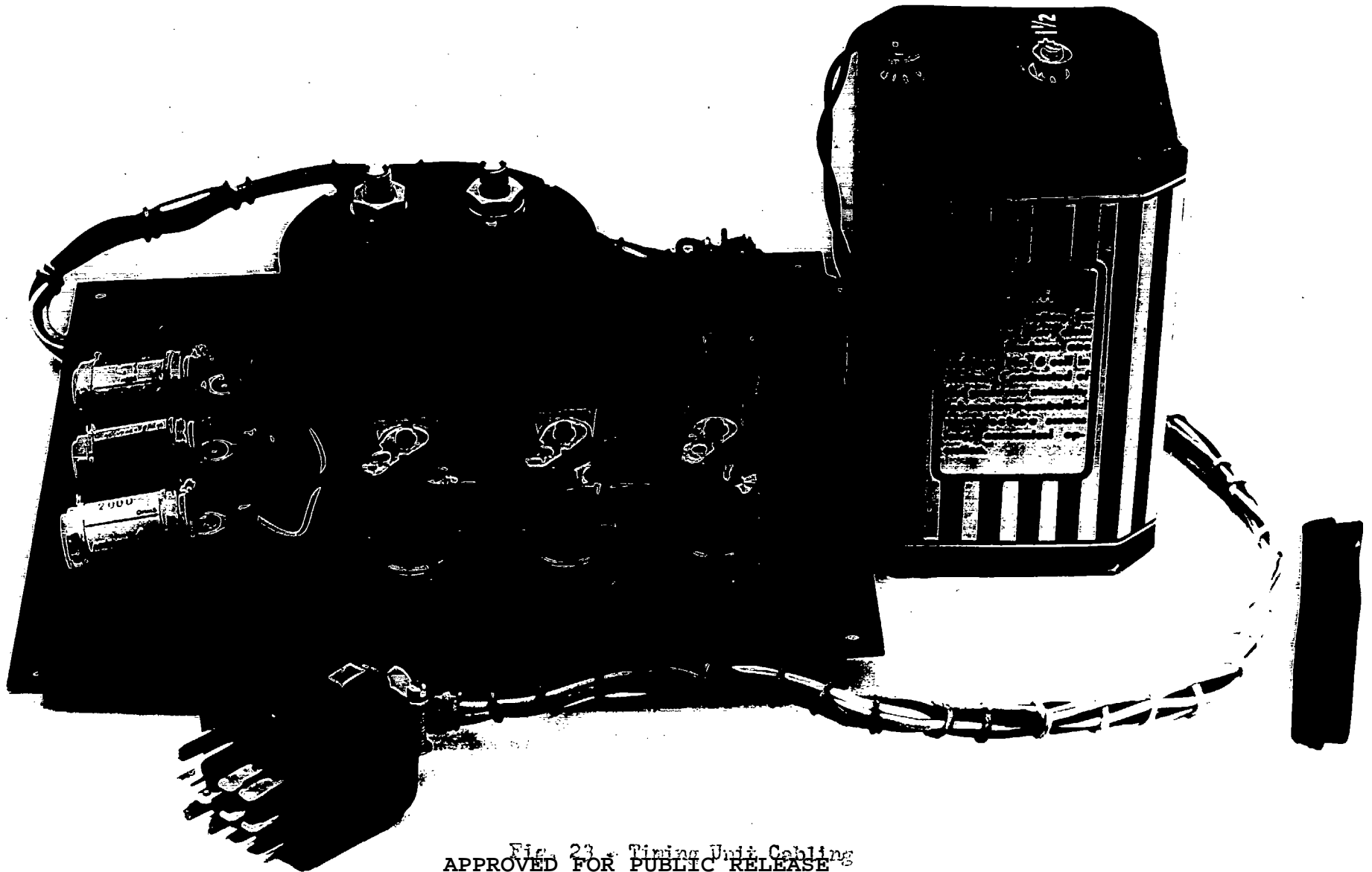

Fig. 23. Timing Unit Cabling



Fig. 24 - Main Timing Unit
Assembly Line - Terminal Island

vacuum tubes (requirement 900) were not in production and these had to be obtained in small quantities from numerous sources. Audio filters were located in RFC surplus stores and were obtained in time only by by-passing considerable red-tape. The job accomplished by the Manhattan Procurement Office in obtaining the necessary components in just a few weeks time was outstanding.

It was originally planned to stow all completed units aboard the AV-17 prior to her scheduled sailing date of March 25, 1946. Timing Units not completed by this date were to be shipped to Bikini by air express as they became available. However, the postponement of the tests made it possible to procure all of the Timing Unit components, prior to the AV-17's new sailing date of April 17, 1946. All Units not completed by April 17 were placed aboard the AV-17 to be assembled while enroute to Bikini.

On February 19th a prototype Timing Unit was brought to Terninal Island by Los Alamos personnel. After a conference between the Los Alamos representatives and the Shipyard's Design Dept., drawings were made for the complete Timing Unit. The Carpenter Shop ^{completed} ~~commenced~~ building the 300 wooden boxes and 30 additional small waterproof boxes for the Timing Box Test Units on February 24th.

Sub-assemblies of filter-relay unit components were started simultaneously with the box building. Since Timing boxes were to have from one to three channels, all chassis were punched to accommodate three channels. Bakelite resistor cards were made with all the small components necessary for one channel mounted on them. Small cables containing all the wiring for one channel were made up on special jigs. These cables were connected to the resistor cards, so that when the resistor

cards were mounted on the chassis there were few electrical connections to be made. The completed filter unit was tested for correct electrical operation before being installed in the Box. (See Fig. 25)

During the early phases of Timing Box production, the number of people working on the project varied from day to day. There were fifteen Electronics Technician's Mates and one Chief ETM, working consistently five and one half days per week. The civilian employees of the Radar Repair Dept. were available at all times. However, during the slack periods caused by slowdowns in supplies, these people were not taken away from their normal duties. These periods of retarded production were not the fault of the Procurement Office nor the Shipyard. Certain materials were just naturally scarce and were flown to Terminal Island in small quantities from all over the country. At the peak of production during the last two weeks of the job, a maximum of 60 people were working on the project. A rough figure of 10,000 man-hours represents work required for the building the filter-relay units and assembling the Timing Boxes. This figure does not include the work done by the Carpenter Shop or the Sheet Metal Shop. The cooperation received by the various departments of the Shipyard was splendid.

3.5. Test Procedure on the USS Cumberland Sound.

Approximately two-thirds of the timing units had received complete tests at Terminal Island. Facilities were installed to continue production tests aboard the AV-17. A laboratory thirty feet by thirty five feet with benches around three bulkheads was used for test purposes. Two test set-ups were used. One involving a Hewlett-Packard audio oscillator and an AC Vacuum tube voltmeter was used for the checking of the filter units. The operating voltage for each channel was measured

Fig. 25 - Production Testing
Filter - Relay Units

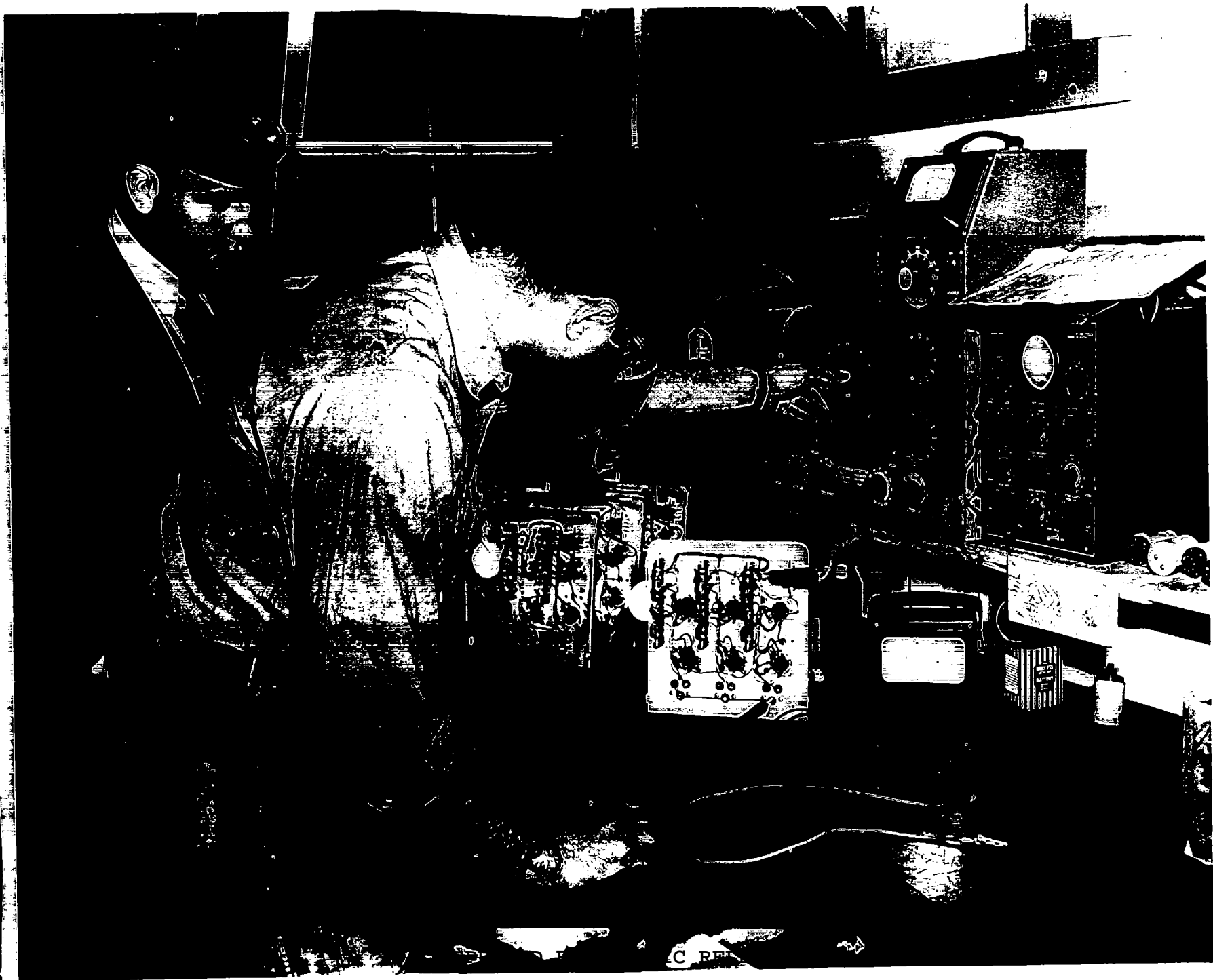

C. RE

to determine if it fell within the limits of 0.8 to 1.4 volts. One of the special test boxes was used to indicate relay operation. The second test set-up employed a Model LP-5 signal generator externally modulated by an audio oscillator. The audio output voltage of the receiver was measured with a portable Hickock rectifier type voltmeter similar to those used in making field checks. Relay operation was indicated on a test unit.

Measurements on the SCR-694-C receivers indicated that the rf input required to obtain the most satisfactory AVC action occurred at 3000 microvolts. Calculations indicated that this field intensity should be obtainable in practice by using two to five sections of the SCR 694 whip antenna, the choice depending upon the operating range and location. The audio input signal required to obtain satisfactory performance from the filter chassis was dependent upon frequency, and a signal level of 2.5 volts at 830 cycles was chosen as the test standard. Therefore the bench tests on the receiver principally consisted of adjusting the audio gain control to produce 2.5 volts of audio output, across the 250 ohm tap, with an input signal of 3000 microvolts, 30 percent modulated at 830 cycles per second.

A short receiving antenna was installed on the signal bridge laboratory and signal from the timing transmitter was carried by coaxial cable to the timing box test bench in the second platform laboratory. Using signals received on the pilot antenna, the transmitter modulation percentages were adjusted to produce equal outputs at each of the audio frequencies. Since there was some variation on the pick-up of the pilot antenna, presumably caused by swinging crane booms, the timing boxes were normally adjusted with signals from the signal generator.

[REDACTED]

An attempt was made to improve the audio frequency response of the receiver, to make possible equal modulation percentages at the transmitter for each of the audio tones, but all the solutions required major modifications in the receivers and were therefore not incorporated.

The 300 timing boxes produced at Terminal Island were delivered aboard the AV-17 a few days before sailing and stowed in two locations. Approximately half of them were stowed in the air-conditioned laboratory spaces and the other half in #8 hold. The problem of moving the boxes from the hold to the laboratories for tests was greater than anticipated and considerable labor would have been saved if all the units had been originally stowed near the laboratory. The boxes are bulky but it was found possible to stow all units in two laboratories having a width of thirty feet and a length of seventy five feet. The effect of temperature upon the equipment is not definitely known but the life of selenium rectifiers in the units which were stowed in #8 hold appeared to be shorter than those in units stowed in the air-conditioned laboratories.

IV. FIELD ACTIVITIES

4.1. General

The activities of the timing-unit field parties may be divided into four categories. The first and most time-consuming of these is the physical installation of the boxes aboard target vessels and on the islands. Second is the checking of performance, which had to be done at frequent intervals to pick up troubles as they developed. Third was maintenance; primarily replacement of batteries and of small components that failed. Finally, there was the process of turning the equipments on prior to the actual tests themselves.

4.2. Installations.

A typical installation party would leave the AV-17 with the following material: timing boxes, whip and horizontal antennas, batteries, spare tubes, relays and selenium rectifiers, an electronics repair kit, a timing-unit test box, and miscellaneous mounting and lashing materials. (See Fig. 26).

The boxes came from the laboratory fully adjusted, so as to produce an audio output voltage at 850 cps. of 2.5 volts when a 3000 microvolt signal, properly modulated, was impressed on the antenna terminal. This audio voltage may be altered either by adjustment of the audio gain control or by varying the input signal strength. To obtain uniform conditions in the field, it was decided to operate at a fixed r-f level, chosen with regard to optimum AVC conditions. By pre-setting the audio gain in such a way that a definite value of audio voltage would be obtained for a specified input voltage, it became possible to adjust the antenna to produce this voltage without carrying elaborate equipment into the field. In practice, this procedure worked very well, and the parties were soon able to learn the length of antenna required in a given type of location. Later, the rule of non-adjustment of the audio gain control in the field was relaxed somewhat, particularly in the case of installations in poor locations, where one could not obtain 3000 microvolts with a five-section whip antenna. In general, however, when the audio voltage failed to come up to standard, or exceeded it greatly, it was assumed that the receiver had in some way changed since the laboratory adjustment, and it would be replaced. Incidentally, in nearly every case where such changes were found, the trouble could be cured in the laboratory by replacing the tubes and re-adjusting the control.

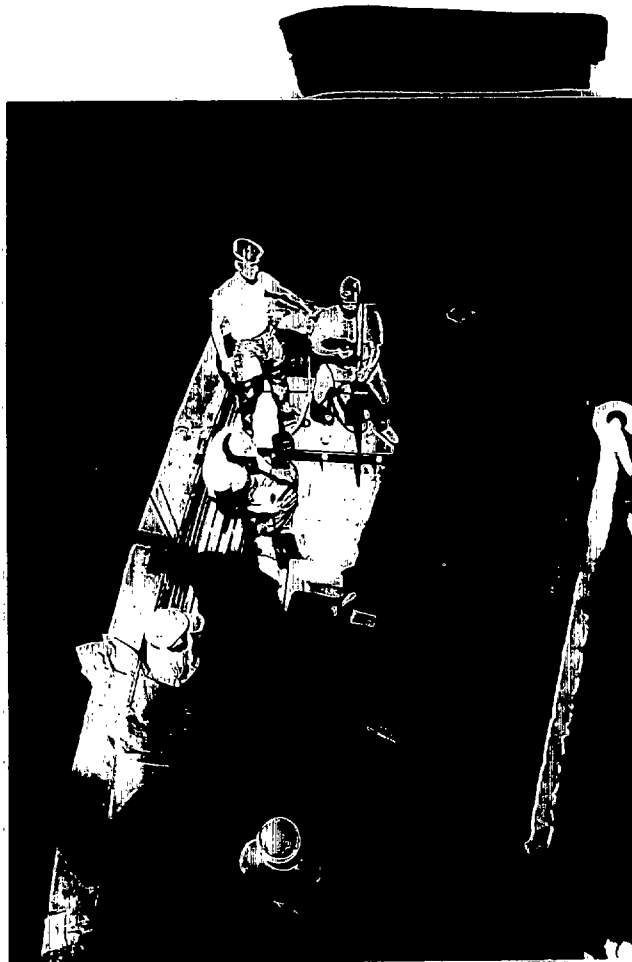

Fig. 26. Timing Box Party Leaving AV-17



Fig. 27. Gun Turret Installation

[REDACTED]

The boxes were provided with two long pieces of wood screwed down inside the cover. In the field, these were fastened to the bottom of the outside of the box, and formed a firm foundation for the boxes when a suitable location would be found. In general, the requirements of good signal pick-up were predominant, although where possible, proximity to the customer's equipment was considered. The box would be set in this position and firmly secured, usually with line lashings around the legs or through the carrying handles. The box would then be opened, the cover-plate over the hole for the antenna mast base knocked out, and the mast base installed. The set would then be turned on and the test-box plugged in. After connecting the audio voltmeter in the electronics repair-kit to the audio output jack on the SCR 694-C receiver, the set would be tuned up and the audio voltage noted. The cyclic keyer in the timing control laboratory was arranged to key out in succession over a 1-minute cycle all of the timing tones. The 850 cp tone was longer than the rest, and was used both for tuning up and for selecting the antenna length. While this tone was being received, antenna sections were added until the required 2.5 volts was obtained.

On board the target ships, by far the best location from the signal-pickup point of view was the forecastle. For ships well clear of the center of the array, two sections of antenna were more than sufficient, in contrast to the minimum of three for any other location, and in no case was more than three required. That freedom from interference by superstructure was more important than elevation is clearly demonstrated by the fact that in the four raft installations, where the base of the antenna was only about six feet above the water, a two-section antenna was adequate, in spite of the close proximity of many target ships. Signal-bridge locations were usually satisfactory, although some cases

[REDACTED]

showed great variability in signal strength, due to the swinging of the ship in the wind. In such instances, the timing units were moved to the forecastle, with great improvement in constancy of signal. Gun-mounts and turrets were often used with success; these are usually well clear of the ship's superstructure, (See Fig. 27). Ammunition ready-boxes were convenient since the fasteners made good loops for the lashings. Installations on the fantail and after gun-mounts were often made. In most cases, these worked, but cannot be regarded as fully reliable. If the AVC characteristic of the SCR 694-C receiver had been more satisfactory, the choice of location would have been less critical; as it was, the audio signal had to be confined to the range from 1.8 to 3.5 volts to avoid both non-operation and operation of the wrong channel from the harmonics generated within the receiver.

The amount of work involved in a field party may be gauged from the fact that a hard-working party of three men could make about eight installations in an eight-hour day, and a party of two men could check from 12 to 20 installations, depending on location and the number of repairs that had to be made.

The installations on the islands took considerably longer. Most of these were made in the various photographic and instrument towers. A simple island installation on Bikini is shown in Fig. 28. The boxes were generally put under cover, inside the tower enclosure or inside a hut on the ground, so that external antennas were required. This involved mounting a mast-base bracket somewhere, or stringing up a suspended wire antenna. Also, for the towers, considerable effort was required to lift the boxes, which weigh about 70 lbs. as well as test gear and installation materials, to the tops of the 75-foot towers.



Fig. 28. An Installation on Bikini Island



Fig. 29. A Shipboard Installation



[REDACTED]

There is some evidence that equipment failure in the island installations was less frequent than in the ship installations. If this be so, it is probably due to better shelter from the intense heat of the sun. Shelter from rain is probably less important, as the wooden boxes are quite tight.

The installations in aircraft were made mostly by the instrumentation groups. The timing unit components were removed from the water-tight boxes and mounted on the bulkhead on shock mounts. Usually, an existing Loran antenna was used, which precluded the possibility of adjusting the r-f level, so the audio gain controls were set while the plane was orbiting in approximately the correct position about the target area.

One member of the Los Alamos Field Group spent most of his time prior to Test Able getting the airborne equipment in shape. His problem was complicated by the fact that the wiring within many of the planes connecting the timing unit to the cameras was defective, a fact which was not uncovered until about three weeks before Test Able.

In general, when the installations were made, the AV-17 would be in her berth inside the lagoon, close to the target array. Therefore, the final adjustment of antenna lengths was made on special days when the ship would assume her station approximately 15 nautical miles from the center of the array.

4.3. Field Maintenance.

Having completed the physical installation, the field party would then check the box. Checking consisted of measuring the voltages of the A, B, and C batteries, checking the audio voltage on the 850 cps tone, and observing the proper functioning of the relays. Battery voltages and relay operation were conveniently observed with the special



Fig. 30 Closeup of Timing Box
Installation of Fig. 29

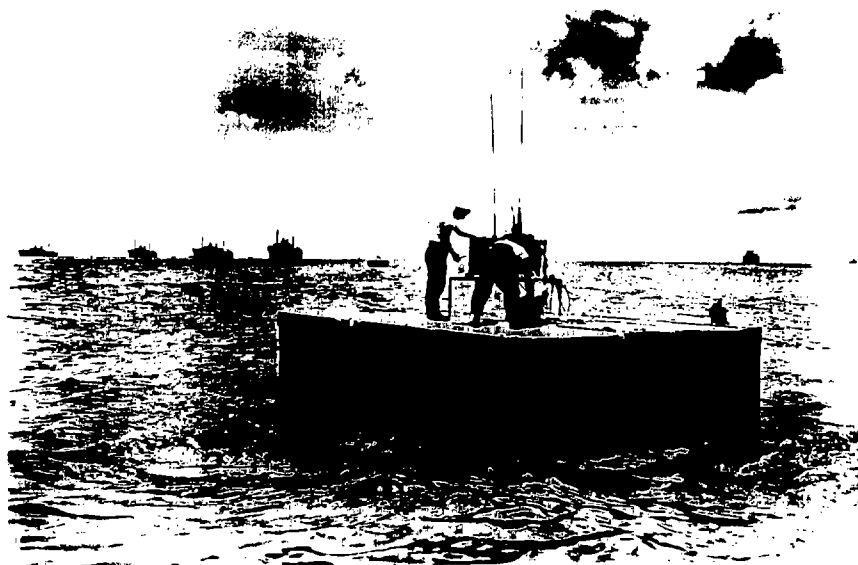

Fig. 31 A Raft Installation

[REDACTED]

test-box provided. This was plugged into a test-plug inside the timing unit. It contained a voltmeter, three push-buttons and three pilot light. Battery voltages registered on the meter directly by depressing the buttons in turn, and relay operation was indicated by the lights as the relay contacts closed. Timing channel contacts are normally opened, while the "recycle" contacts are normally closed. Therefore, the normal position of boxes equipped with recycle channels would show the two left-hand lights out and the right-hand one on. As the various tones came over the transmitter, first the left-hand light, and then the middle light would come on, staying lit because of the locking circuit in the filter chassis. Then the recycle pilot would extinguish, and with it the other two pilots, as the recycle relay cleared the corresponding channels. The cycle would then be repeated for each sequence of signals received.

Two types of failure were frequently observed in the field. In one, the channel would fail to operate even though the voltmeter showed that the receiver output was up to standard. In nearly every case, this was found to be due to the failure of the selenium rectifier. At first, such defective chassis were brought back into the laboratory for repair, but as the number of such failures increased, it was decided to make repairs in the field. In the second type of failure, considerably less frequent, the relay would be observed to operate as soon as the power was turned on, whether or not an audio signal was present. This was invariably due to a defective 1D8GT tube, and was repaired on the spot by tube replacement.

Perhaps 10% of the receivers had to be changed at one time or another, but by the time of the actual tests, the poor receivers had been weeded out, and no overall failure in either the Able or the Baker

shot was definitely traced to receiver failure.

Many of the batteries were changed in spite of the fact that few if any of the units were ever operated for the 50 or 60 hours that the batteries should provide. This was probably due to the fact that many of the batteries had exceeded the manufacturer's recommended shelf life by from six months to a year. Those batteries were used because they were available and the location of new batteries would possibly have delayed the program. No case of failure was ever traced to batteries. Our standards were sufficiently high, so that the unit was still in an operating condition with the old batteries when a new set was installed.

4.4. The Final Operations.

The timing units were actually used under operational conditions to operate equipment on four occasions: the two tests, Able and Baker, and the rehearsals, Queen and William. On Queen-Day, some trouble was experienced with premature operation due to interference, so it was decided to work out a procedure such that no timing box would be energized until the actual day of the test.

The clocks in the units were provided with a cam which allowed a microswitch to turn the equipment on for six out of the twenty-four hours each day until the movement became unwound. The cams were set to turn on the equipment at 0730, Bikini time, so that once they were set the day before the test, the equipment would be energized until 1330 of that day, and then would be off until 0730 of the following day. So, on Able day, those boxes visited before 1400 received a battery test and then were left turned off. After 1400, the boxes were tested and left in the "clock" position, and those boxes covered in the morning were revisited and the switches turned to "clock", without opening the boxes. Before the William and Baker adjustments it was decided that the clock-winding

and setting trips in the morning were unnecessary, so the whole job was accomplished after 1400 the day before the test.

The final operation therefore consisted in removing the customer's plug (necessary, to prevent the cross-connections in the test-box from operating or short-circuiting his gear), measuring the battery voltages, checking the cam setting, winding the clock, setting in the correct local time and reconnecting the plug. This took an average of about eight minutes, exclusive of transportation time between installations.

4.5. Interference.

The effect that interference can have on a timing unit is to cause one or more of its channels to operate at the wrong time. Two types of false operation should be noted. In the first type, a time-channel operates prematurely, causing the instrumentation to go off at the wrong time. In the second type, the recycle channel operates after one of the time channels has operated properly, causing its locking circuit to release, and preventing or stopping the operation of the equipment. Either type is equally disastrous to the customer, but the second type leaves no evidence, and may be interpreted as a failure of the time-channel to operate.

In general, interference was confined to voice modulated signals of great strength on carriers in the 2 to 5 mc. band, strong atmospheric disturbances - primarily direct lightning flashes, and pulsed signals where the pulse repetition frequency happened to coincide with the passband frequency of one of the filters. In one case, it was found that the -2 minute signal was used to turn on a spark-coil for putting markers on a film. Ten seconds after this signal was received, the heaters of some thyratrons were warmed up, and the resulting spark signal promptly

[REDACTED]

and effectively operated the recycle channel. The tube in this channel was removed, and then it was found that the -2 channel would operate from the spark noise, causing premature operation of the equipment. This is cited to show the importance of overall systems tests.

Interference from modulated carriers close to the timing transmitter frequency is quite intangible, depending as it does on the interaction between two or more carriers at the grid of the first stage of the SCR 694-C receiver. It was impossible to predict just what conditions would prevail at a given time and location. Cases of false operation were frequent enough to be a real problem, yet infrequent enough to make it almost impossible to pin them down to particular transmitters. Complete radio silence was requested but was not obtainable and many operational circuits were running during the tests.

Two cases of premature operation received special publicity as they involved flash-bombs that could be seen by the entire fleet. The first failure was almost certainly due to atmospheric; there was a heavy rain-squall over the installation at the time the set was turned on by the clock, and the flash was reported at just about this time. In the second case, the clock had turned the set on about an hour before the detonation took place. But because of a delayed bomb run and postponement of the test, a sudden flurry of radio communications was started among the ships and planes of the task force at the time of the explosion and this may have had something to do with giving sufficient stray signal at the unit to set it off. Recommendations for changes in the timing units to reduce the ill-effects of interference are made elsewhere in this report.

4.6. Installations

Listed by the groups using the timing units the following are the installations made for Tests Able and Baker:

4.6.1. Timing Box Installations for Shot "Able"

Bu/Ships, Electronics, Mr. Moran, AG 76

| <u>Type Box</u> | <u>Location</u> |
|-----------------|---------------------------------------|
| 30M 2M R | ACMCEN, Top of Radar Tower (not used) |
| " " " | ACMCEN, Radar Trailer |
| " " " | ACMCEN, Radar Hrt |
| " " " | ACMCEN, Radar Hrt |
| 30M 20S R | USS Avery Island, Radar Bridge |
| 30M 5S R | USS Avery Island, Radar Bridge |
| 2M 5S R | ACMCEN, Radar Trailer |
| 20S 5S | USS Avery Island, Radar Bridge |
| 20S | ACMCEN, Sona Buoy Hrt |
| 20S | ACMCEN, Sona Buoy Hrt |
| 5S 2S | USS Avery Island, Radar Bridge |
| " " | USS Avery Island, Radar Bridge |
| 5S | BIKINI, Hut between Towers #4 and #5 |
| " | BIKINI, Top of Tower No. 4 |

Bu. Ships, Oceanographic, Lt. Comdr. Morris.

| <u>Type Box</u> | <u>Location</u> |
|-----------------|--|
| 30M 2M R | NAMU, West end of island |
| " " " | NAMU, West end of island |
| " " " | YURO, On the beach |
| " " " | YURO, On the beach |
| 5S 5S | BIKINI, No. 1, Television Tower |
| " " | CHERRY, Seismic Hrt |
| 5S | ACMCEN, Seismic Hrt |
| " | ENYU, Seismic Hrt |
| 2S | BIKINI, North Line of PIPES |
| " | BIKINI, Center Line of PIPES |
| " | BIKINI, Between Towers #2 & #3 (Seismic equip) |
| " | YURO, In Hrt |
| " | NAMU, Top of Hrt |

Los Alamos Photography, Mr. Brimmer, AV-17

| <u>Type Box</u> | <u>Location</u> |
|-----------------|----------------------------|
| 2M 5S R | BIKINI, Brimmer's Tower #3 |
| " " " | ENYU, Brimmer's Tower |
| 2S with DELAY | BIKINI, Brimmer's Tower #3 |
| " " " | ENYU, Brimmer's Tower |

Gamma Measurement, Mr. Tuck, AV-17

| <u>Type Box</u> | <u>Location</u> |
|-----------------|-----------------------------|
| 20S | APA 68, Aft. Deck House |
| " | APA 69, Aft. Deck House |
| " | APA 70, Aft. Gun Mount |
| " | BB 33, N. 4 Gun Turret |
| " | CA 24, N. 2 Gun Turret |
| " | Nagato, Main Mast Starboard |

Bu. Ships, Blast Measurement, Cdr. Gerlock, AV-14

| <u>Type Box</u> | <u>Location</u> |
|-----------------|---------------------------------|
| 30M 20S R | APA 57, Signal Bridge |
| " " R | APA 65, Signal Bridge |
| " " R | APA 64, Signal Bridge |
| " " R | APA 63, Signal Bridge |
| " " R | DD 404, No. 4 Turret |
| " " R | DD 408, Forward of No. 3 Turret |
| " " R | To be installed on Life Rafts) |
| " " R | To be installed on Life Raft) |
| " " R | To be installed on Life Raft) |
| " " R | To be installed on Life Raft) |
| 20S | APA 64, Signal Bridge |
| " | APA 65, Signal Bridge |
| " | DD 404, No. 4 Turret |

Boxes delivered to the AV-14

Bu. Ships, Photography, Lt. Comdr. Shafton, USS HAVEN

| <u>Type Box</u> | <u>Location</u> |
|-----------------|-----------------------------|
| 20S-20S | BB 38, Foremast |
| " " | CV 3, Forward Sky Lockout |
| " " | DD 419, Flying Bridge |
| 20S- 2S | ENYU, "Life Guard" Tower |
| 20S | APA 61, Bow |
| " | APA 75, Forecastle |
| " | APA 87, Signal Bridge |
| " | BIKINI, "Life Guard" Tower |
| " | DD 402 (not used) |
| " | DD 389, 2nd Gun Platform |
| " | DD 722, |
| " | DD 723, |
| " | IST 661, Bow |
| " | Prinz Eugen, No. 2 Turret |
| " | SS 335, Forward Gun Station |
| " | SS 384, Forward Gun Station |
| 30M-2S | C-54 Photo plane |

Bu. Medicine, Lt. Eicher, USS HAVEN

Type Box

Location

| | | | |
|----|-----|---|----------------------------------|
| 2M | 20S | R | APA 86, Starboard Fantail |
| 2M | 3S | R | APA 83, Aft, Starboard Gun Mount |
| " | " | " | APA 87, Aft, Starboard Gun Mount |
| " | " | " | BB 38, No. 2 Turret |
| " | " | " | CV 3, Aft, Starboard Gun Mount |
| | 5S | | APA 81, Signal Bridge |

Army Air Forces, Col. Cullen, Kwajalein.

14----5S 2S

Units Delivered

Task Group 1.6.3., Cdr. Ballard,

1----2M 20S R

Unit installed in PBM-5, No. 84607.

Bu. Ordnance, Lt. Comdr. Cheeseman, - AV-14.

Type Box

Location

Use

| | | | | |
|-----|-----|----|--|-----------------------------------|
| 30M | 20S | R | ENYU, In Hut | Low Frequency Measurement |
| " | " | " | ENYU, In Hut | Low Frequency Measurement |
| 2M | 2S | R | APA 57, Signal Bridge | Shock Velocity |
| " | " | " | AV 14, Signal Bridge | Radiometry |
| 2M | 2S | R | APA 70, Signal Bridge | Shock Velocity & Free Piston |
| " | " | " | ARDC 13, Top Starb'd Side | " " " " |
| " | " | " | APA 60, Signal Bridge | " " " " |
| " | " | " | Prinz Eugen | Shock Velocity |
| " | " | " | DD 722 | For Dr. O'Brien |
| " | " | " | AOCMEN, Tower "C" | " " " |
| " | " | " | BIKINI, White Beach Tower | Bowen Camera) |
| " | " | " | BIKINI, White Beach Tower | For Mr. Wycoff) <u>Paralleled</u> |
| " | " | " | BIKINI, Wooden Tower | For Dr. O'Brien) |
| ZM | 5S | R | BB 34, No. 4 Gun Turret | Shock Velocity |
| | 20S | 5S | APA 71, Frame 150, Strb'd | Time-Pressure & Free Piston |
| | 20S | 2S | BB 34, No. 4 Gun Turret | " " " " |
| | 20S | | BB 38, Forecastle | Time-Pressure |
| | " | | APA 66, Frame 140, Strb'd | " " |
| | " | | APA 57, Forecastle | " " |
| | " | | APA 70, Frame 140, Strb'd | " " |
| | " | | CVL 22, Forward Gun Deck | " " |
| | 5S | 2S | BB 38, Top Strb'd 5 th Turret | Free Piston |
| | 5S | | APA 71, Forecastle | " " |
| | 2S | | APA 57, Signal Bridge | " " |
| | " | | APA 64, Forecastle | " " |
| | " | | APA 65, Signal Bridge | " " |
| | " | | APA 66, Signal Bridge | " " |
| | " | | APA 79, Signal Bridge | " " |
| | " | | BB 33, Near Strb'd Crane | " " |
| | " | | CA 25, No. 3 Gun Turret | " " |
| | " | | DD 367, Forward of No. 3 Gun | " " |
| | " | | DD 390, No. 3 Gun, Starb'd | " " |
| | " | | DD 404, Top No. 4 Turret | " " |
| | " | | DD 413, Forward of No. 3 Gun | " " |

| <u>Type Box</u> | <u>Location</u> | <u>Use</u> |
|-----------------|------------------------------|-------------|
| 2S | SS 184, Forward Gun Platform | Free Piston |
| " | SS 308, Forward Gun Platform | " " |
| " | APA 85 Not Used | |

Searchlight on BB 36, NEVADA:

2----SPECIAL Boxes on the Foremast.

TIMING BOX INSTALLATIONS TEST "BAKER"
BUSHIPS OCEANOGRAPHIC, Lt. Comdr. Morris, AS-11

NAMU ISLAND

| | |
|-------------|------------|
| -30M- 2M -R | North End |
| -30M- 2M -R | North End |
| - 5S -2S | Top of Hut |

YURO ISLAND

| | |
|--------------|--------------|
| -30M- 2M - R | North of Hut |
| -30M- 2M - R | North of Hut |
| - 2S | Top of Hut |

BIKINI

| | |
|----------|------------------|
| 20S - 5S | Tower 4 |
| -2S | No. Pipes |
| -2S | So. Pipes |
| -2S | Bet. twrs. 2 & 3 |
| 5S - 2S | North End |
| Clock | Spare |

ENYU ISLAND

| | |
|----|-------------|
| 5S | Seismic Hut |
|----|-------------|

AMEN ISLAND

| | |
|----|-------------|
| 5S | Seismic Hut |
|----|-------------|

ENGD - TIME PRESSURE GROUP, Mr. Henderson (AV-14)
Lt. Durr (AV-14)

| | | | |
|-----|--------|--------------|---------------------|
| 20S | MB-33 | Arkansas | Stbd, Focals, Fr-20 |
| " | CV-3 | Saratoga | Stbd, Flt.Dk.Fr-20 |
| " | BB | Nagato | Fantail Fr-310 |
| " | APA-85 | Casgonade | Fr-135 Port 40MM |
| " | APA-66 | Brulo | Fr-135 Stbd. 40MM |
| " | CA-25 | Salt Lake | Fantail |
| " | BB-36 | Nevada | Stbd. Focals, Fr-20 |
| " | BB-34 | New York | #4 turret |
| " | APA-65 | Briscoe | Port Focals, Fr-20 |
| " | APA-71 | Catron | Port Focals, Fr-20 |
| " | BB-38 | Pennsylvania | Port Focals, Fr-20 |
| " | BB | EUGEN | Stbd. Focals. |
| " | APA-60 | Banner | Stbd. Focals, Fr-20 |
| " | CVL | Independence | 40MM Mount fwd. |

BUSHIPS BLAST MEASUREMENT, Lt. Comdr. Dellamano (AV-14)

| | | |
|---------------|--------|-------------------------|
| 30M - 20S - R | APA-85 | Sig. Br. Stbd. Gun Tub. |
| " " " | APA-85 | " " " " " |
| " " " | APA-65 | Focsle. |
| " " " | APA-65 | " |
| " " " | APA-64 | " |
| " " " | APA-64 | " |
| " " " | APA-63 | Sig. Br. |
| " " " | APA-63 | " " |
| " " " | DD-404 | #4 Gun. |
| " " " | DD-404 | " " |
| " " " | DD-408 | #3 Gun. |
| " " " | DD-408 | " " |
| " " " | APA-87 | Sig. Br. |

2 Boxes on each of 4 rafts to be installed prior to "BAKER MINUS ONE".

Clocks with 6-hr. cans - 7 furnished to Lt. Comdr. Dellamano.

BUSHIPS PHOTO GROUP, Comdr. Shafton (CVE-117).

| | | | |
|-----------|---|--------------|-----------------|
| 20S- | SS-384 | Parchae | Conning Tower, |
| " | DD-389 | Mugford | Fwd. #2 Gun |
| " | DD-389 | Mugford | Fwd. 40MM mount |
| 20S - 20S | BB-38 | Pennsylvania | Foremast |
| 20S - 20S | BB-38 | Pennsylvania | Foremast |
| 20S | LST-661 | | Focsle. |
| " | APA-61 | Barrow | Main Dk. Fwd. |
| " | DD-419 | Wainwright | Director Plate |
| 2M 20S | DD-419 | Wainwright | Director Plate |
| 20S | APA-75 | Cortland | Focsle. |
| 2M 20S | APA-75 | Cortland | Sig. Br. |
| 20S | BB | Eugen | #2 Turret |
| " | APA-87 | Niagra | Sig. Br. |
| 2M 20S | APA-87 | Niagra | Sig. Br. |
| " " | APA-70 | Carteret. | Sig. Br. |
| " " | DD-371 | Coyghan | #2 Gun shield |
| " " | LST-545 | | Comm. |
| " " | ICI-549 | | Comm. |
| " " | Bikini Tower 4. | | |
| " " | Enyu Life Guard Tower | | |
| 20S | Bikini Life Guard Tower (Comdr. Langer) | | |
| 20S-2S | Enyu Life Guard Tower (Comdr. Langer). | | |

BUORD - FREE-PISTON GROUP, Mr. Curtis (AV-14)

| | | | |
|----|-----------|--------|---------------------|
| 5S | Nevada | BB-36 | Focsle. |
| " | Nevada | BB-36 | Aft. |
| " | Nagato | BB | Aft. Port Fr-200 |
| " | Nagato | BB | Stbd. Focsle -FR-30 |
| " | Salt Lake | CA-25 | #3 turret |
| " | Salt Lake | CA-25 | Aft. Port Gun Tub |
| " | Hughes | DD-410 | #4 Turret |
| " | Mustin | DD-413 | Search light Plate |
| " | Gasconade | APA-85 | Focsle |
| " | Gasconade | APA-85 | Stbd. Aft. |
| " | New York | BB-34 | Aft. Port |
| " | New York | BB-34 | #5 Turret |
| " | Briscoe | APA-65 | Stbd. Aft Gun Tub. |

0000



| | | | |
|----|-----------|--------|----------------------|
| 5S | Pensacola | CA-24 | Focsle. |
| " | Brule | APA-66 | Focsle |
| " | Brule | APA-66 | Stbd. Aft. |
| " | Trippe | DD-403 | Fwd. |
| " | Wayrant | DD-402 | Fwd. |
| " | Saratoga | CV-3 | Stbd Flt. Hk. Fr-130 |

*BUORD - ABERDEEN CHRONOGRAPH GROUP, Mr. Carr (AV-14)
Lt. Kisser (AV-14)

| | | | | |
|-----|----|-----------|-------|-----------------|
| 30M | 5S | Nagato | BB | Focsle.Aft. |
| " | " | Nagato | BB | Focsle, Aft. |
| " | " | Pensacola | CA-24 | Stbd. Amidships |
| " | " | Pensacola | CA-24 | Stbd. Amidships |
| " | " | New York | BB-34 | #5 Turret |
| " | " | New York | BB-34 | #5 Turret |

* These boxes will be converted to 2M -5S per verbal request of Mr. Carr
7/18

BUSHIPS - ELECTRONICS, Mr. Moran (AGC-76)

| | | |
|-------------|-------------------|-----------------------------|
| 2M - 5S - R | Amen | Radar Hrt |
| 2M - 5S - R | Amen | Radar Hrt |
| 20S | Amen | Sono Hrt |
| 20S | Amen | Sono Hrt |
| 2M - 5S - R | Amen | MPG-1 Trailer. |
| 2M - 5S - R | Amen | MPG-1 Trailer |
| 20S - 5S | AG-76 | Stbd. Fwd. 20MM Mount |
| 20S - 5S | AG-76 | " " " " |
| 5S - 2S | AG-76 | " " " " |
| 5S - 2S | AG-76 | " " " " |
| 5S | Bikini | Tele. Hrt |
| 5S | Bikini | Tele. Hrt |
| 2M | APA-65 | Briscoe - Sig. Br. |
| 2M | APA-64 | Bracken - Sig. Br. |
| Zero Time | ARDC-13 installed | stbd. wall aft for "W" day. |
| Zero Time | ARDC-13 installed | stbd. wall aft for "W" day. |

GAMMA MEAS., Mr. Tuck (AV-17)

| | | |
|--------|--------|-----------|
| 20S - | APA-70 | Fwd. |
| 20S - | APA-77 | Fwd. |
| Nagato | BB | Mainmast. |

BUMED, Lt. Comdr. Smith, Lt. Eichar.

| | | |
|--------------|--------|----------------------|
| 2M - 20S - R | APA-86 | Stbd. Fantail |
| 2M - 5S - R | APA-83 | Aft. Stbd. Gun Mount |
| 2M - 5S - R | APA-87 | Aft. Stbd. Gun Mount |
| 2M - 5S - R | CV-3 | Dir. Plate. |
| 5S - 2S - R | APA-71 | Fwd. |
| 5S | APA-81 | Sig. Br. |

45



LOS ALAMOS PHOTO, Mr. Brizner

BIKINI

2M - 5S - R Tower 3
2S Tower 3

ENYU

2M - 5S - R Tower
2S Tower

BUCRD, BIKINI, Mr. Wycoff

2M - 2S Tower 1
2OS Tower 1

BUCRD, ENYU, Mr. Snavely

30 M - 2OS - Hut
30M - 2OS - Hut

T.G. 1.6.3., Cmdr. Ballard.

2M - 2OS - R in FBM-5 #84607

V. SUMMARY OF RESULTS5.1 Test Able

A total of 127 timing units were installed in aircraft, on islands, on rafts or on ships participating in Test Able. The timing control laboratory and all field installations were completed on schedule in advance of the Queen Day rehearsal. Before Able Day each of the boxes had been checked a minimum of four times with the AV-17 anchored within the Atoll and, with but one or two exceptions, the performance of each installation was checked on two different days with the AV-17 out to sea. The results of these tests indicated that over 96 percent of the boxes were found to be in satisfactory operating condition two days following the previous check and that the rate of deterioration was on the order of two percent per day. The principal cause of failure was due to the selenium rectifiers as discussed in Section IV-c of this report.

The performance on Able Day was partially marred by the late transmission of three of the timing signals. Because of failure to receive the bomb release tone from the bomb-carrying aircraft on the Able Day dry run, the console operator was alerted to the need for a

manual clock start. Since this manual start was a departure from the routine operation, which had been rehearsed many times before, it became necessary for the console operator to make a last minute decision. After preparations for a manual start had been made a tone signal was actually received on the live bomb run. Due to the unusual mental tension, brought about by the last minute change in plans, the console operator prematurely started the automatic clock in operation. On the basis of the standard voice broadcast from the aircraft there appeared to be adequate time available to let the clock run through a cycle and return to the initial starting position before the actual bomb release, and the console operator elected to do so. The actual bomb release occurred just before the auto-matic clock was ready for a new start and it was therefore necessary to key out the signals manually. This last minute shifting of plans disrupted the timing laboratory procedure to the extent that no exact time of bomb release tone-break was obtained. Therefore signals were manually keyed out using the start of the bombardiers - 2 minute tone signal as a time reference. The -20 second signal was actually transmitted at -9 seconds and the -5 and -2 second signals were transmitted at +2 and +5 seconds respectively.

It is difficult to estimate the exact loss of instrumentation data due to the delayed signals; but in nearly all cases the instruments expecting the -20 second signal were in operation well before the blast and satisfactory data obtained. Some of the instruments expecting the -5 and -2 second signals were operating seismic equipment or were recording blast pressures and wave heights at island locations several miles distant from the blast. These instruments should have produced satisfactory records. Instruments which are known to have suffered because of the late transmission of signals are the high-speed cameras and free piston blast pressure gauges. No definite performance figure

is available but it is believed that about 86 percent of the instrumentation received adequate timing signals on Able Day.

Information is available on the functioning of the timing units from user's reports and from an operating check on Able plus five with the AV-17 located within the Atoll. 84 percent of the installations covered by users' reports operated satisfactorily and some of the failures claimed above could have been due to faults within the instrumentation gear since it is an overall figure. 94 percent of the installations covered in a survey made on Able plus five performed satisfactorily when checked against standard test transmissions from the AV-17 at its berth in the lagoon. Twenty-two timing boxes were destroyed by the blast and incomplete information is available on approximately 15 of the other Able Day installations.

5.2. Test Baker

A total number of 129 field installations of timing boxes were made for test Baker. All of these units were tested at least once with the AV-17 at sea and several times with the timing control ship in the lagoon. The operation on Baker Day was completely routine with all of the timing signals being transmitted on schedule in synchronism with the bomb firing signals. A recording made on the AG-76 indicated that the zero time signal was transmitted within 0.05 seconds of the scheduled "How" hour of 0835 (Bikini time).

Because of the re-entry difficulty after the test, only scattered information on timing box performance is available. Existing information indicated that the overall performance of the boxes was comparable to that of Able Day. Because of the greater number of dual installations it is anticipated that overall performance figure will be better than 90 percent.

VI. RECOMMENDATIONS AND COMMENTS ON PROGRAM

6.1. General

The actual field results have proven that the basic phil-

osophy underlying the timing system developed for use during the Able and Baker Atomic tests is sound. In view of the difficulty in servicing complicated electronic equipment under field conditions the elementary form of timing system that was employed has considerable merit. If any large quantity of installations is to be required for a similar timing program it would appear advisable to employ a comparable system incorporating equipment refinements rather than any basic changes. If, however, the total number of field installations could be reduced considerably then a more complex system might prove advantageous.

The radio frequency chosen for the timing system was satisfactory in all respects. Unless there are a relatively few installations to be made, which might make directional antennas practical, it is recommended that the same general frequency range be employed. Complete radio silence was originally promised in the two to five megacycle band to minimize the possibility of interference; but in actual practice numerous communications equipments were declared essential and allowed to operate in this part of the frequency spectrum on Able and Baker days. Navy communication equipment does not normally operate in the standard broadcast band, and therefore, it may be advantageous to shift to a frequency near one megacycle per second to avoid interference.

6.2. Timing Control Laboratory

The importance of eliminating the necessity of making any last minute decisions within the control laboratory can not be emphasized too strongly. It appears desirable to start the operation in motion several minutes in advance of the explosion time and rely on automatic equipment, rather than human judgement during this period of intensive mental stress. In an operation involving timing and firing circuits that are tied into

████████████████████

a common clock system, interlocks capable of stopping the timing signals in the event of faulty firing repeat-back data may be advisable. For an air drop, similar to Able day, the existing form of starting mechanism should prove satisfactory. However, two radio channels and starting devices should be employed for reliability.

With the exception of those items mentioned in the above paragraph, the equipment was installed in the timing control laboratory has proven itself satisfactory in all major respects. Several minor refinements could be incorporated to advantage. A recording oscillograph or similar instrument should be used to make a time record of the signals which are transmitted and if possible, these signals plus reference time signals from WWV or NPG and signals of the master clock frequency should be included on the same tape. Because of the high power of timing and firing transmitters nearby, radio reception from the laboratory in the 2 to 10 megacycle region was difficult. Some fundamental work on this problem, using filters, and possibly the locating of receiving antennas near the forecastle or fantail of the ship may help to alleviate this difficulty. The use of VHF walkie-talkies for field parties would be a large step in minimizing the seriousness of the internal interference problem. The physical facilities provided in the timing control laboratory are excellent with but one exception; the noisiness of the air-conditioning system. Since there is a large volume of radio communication necessary within the control laboratory the added background noise should be eliminated. In actual practice, the air-conditioning fan was secured during the vital periods of the Able and Baker Day operations.

4.3. Timing Units

Several improvements should be incorporated in timing boxes constructed for any similar program. These are discussed below:

UNCLASSIFIED

1) Sharper audio filters should be used to reduce the probability of false operation. No difficulty should be encountered in keeping the audio modulation tones within one percent of their assigned frequencies and a filter unit with a bandwidth of 3 or 4 percent would provide a considerably greater degree of protection against interference than the 20 percent filters now in use.

2) The only major component in the present timing boxes which has caused difficulty due to failures has been the selenium rectifier. About 15 percent of the rectifiers have failed during the four months that they were under observation. Since the rectifiers were operating well within their ratings, the reason for this short life is not known; but it may possibly be attributed to temperature. A more reliable form of rectifier should be employed.

3) Each timing unit should be capable of responding to all of the time intervals transmitted from the central station. This would eliminate the need for having boxes constructed in accordance with a prescription. It has been found in practice that instrumentation personnel frequently alter their requirements and this universal timing would simplify bookkeeping and last minute modifications.

4) It would be helpful to incorporate within the timing unit a set of lights indicating the status of the relays. It should be possible to accomplish this with a negligible power consumption by using 1/8 watt neon bulbs in the plate circuits of the relay tubes.

5) A spring wound clock which with an adjustable cam capable of being set to any desired interval as well as "on" time would be an advantage. The clock should be capable of providing at least 24 hours of "off" period before entering the "on" sector. A recording dial indicating the time at which relay operation occurred would be helpful, but not vital.

UNCLASSIFIED

UNCLASSIFIED

6) A lighter and less bulky waterproof box would help considerably in handling the timing unit since they must be transported in small boats and carried up and down gangways.

VII. ACKNOWLEDGMENTS AND SECTION PERSONNEL

While the administration and technical direction of the Crossroads timing program was the responsibility of the timing section of the Los Alamos Group, the execution of the project was greatly dependent upon the efforts of many other agencies. The cooperative manner with which all the various organizations participating in the Crossroads timing program carried out their part of the work is outstanding. The program was faced with a very difficult time schedule which was satisfactorily met only because of the energetic and enthusiastic manner displayed by the personnel involved.

Excellent cooperation was obtained from the Crossroads Electronic Coordinating Officer, Captain C.L. Englemann in securing equipment and Navy personnel to assist in the work. The staff of the U.S. Navy Drydocks, Terminal Island, Cal., participating in the timing box production program and the installation of transmitting equipment and laboratory facilities on the USS Cumberland Sound, turned in an exceptionally fine job. Captain Hamilton, Yard Commandant; Cdr. Reece, Yard Planning Officer; Lt. Cdr. Lovci, Electronics Planning Officer; Mr. Peters, Electronics production supervisor; and Mr. Sterner, Electronics Design Officer; and their staffs were extremely cooperative and contributed greatly to the work.

In spite of the very short time available, the Manhattan District, University of California procurement group successfully located and procured numerous hard-to-find components required for the program.

UNCLASSIFIED

UNCLASIFIED

The work received special expediting at Los Alamos by H.S. Allen and his staff. Particularly worthy of note was the work of Mr. Kenny Cox of the Los Angeles Procurement Office for his untiring efforts in locating production supplies.

The staff of the USS Cumberland Sound, under the direction of Capt. Horney, capably handled a continuous series of problems in connection with materiel stowing, our heavy boating requirements, and ship movements while we were conducting special tests at sea. The excellent cooperation displayed by all the ships' staff during the four months at sea contributed in a major way to the work accomplished.

The following constituted the Timing Section of the Los Alamos Field Group:

William Blackford
Lawrence Diener
E.L. Dodds
Eric Durand
Norman Haley
J.F. Stiles
R.O. Webster
Jerome Wiesner
Herbert Weiss

The following officers and men were assigned to the Los Alamos Group for the duration of the Tests:

| | |
|--------------------------|------------|
| Lt. Cdr. R.E. Hildebrand | R. Fadeley |
| Lt. Cdr. S. Burris | R. First |
| Chief ETM Lambrecht | F. Gordon |
| F. Andrews | R. Hanson |
| J. Bartlett | G. Haydon |
| J. Beglinger | V. Homings |
| B. Brunsmier | R. Hill |
| R. Christianson | L. Lee |
| H. Cook | W. Lund |
| W. Deputy | D. Tolles |
| A. Dunham | |

UNCLASSIFIED

~~SECRET~~

UNCLASSIFIED

DOCUMENT ROOM

REC. FROM J.M.

DATE 10/1/46

REC. NO. REC.

UNCLASSIFIED